



















# CUPRINS

	BURGHIE SDS-PLUS 4 MUCHII CAP INTEGRAL DIN CARBURA METALICA Ø 5 - 10 MM	8
	BURGHIE ROTOPERCUTIE SDS-PLUS 4-MUCHII Ø 11 - 16 MM	12
	BURGHIE ROTOPERCUTIE SDS-PLUS 4-MUCHII Ø 18 - 32 MM	14
	BURGHIE ROTOPERCUTIE SDS-PLUS 2-MUCHII Ø 4 - 26 MM	15
	BURGHIE ROTOPERCUTIE SDS-PLUS SEMI PROFESIONALE Ø 4 - 16 MM	21
	BURGHIE ROTOPERCUTIE SDS-PLUS BASIC Ø 4 - 16 MM	22
	BURGHIE ROTOPERCUTIE SDS-PLUS ACCESORII	24
	BURGHIE ROTOPERCUTIE SDS-MAX 4-MUCHII Ø 12 - 15 MM	26
	BURGHIE ROTOPERCUTIE SDS-MAX 4-MUCHII Ø 16 - 52 MM	27
	BURGHIE ROTOPERCUTIE SDS-MAX 2-MUCHII Ø 12 - 15 MM	29
	BURGHIE ROTOPERCUTIE SDS-MAX SEMI PROFESIONALE Ø 14 - 40 MM	30
	BURGHIE ROTOPERCUTIE SDS-PLUS / SDS-MAX EXTRACTOARE DE PRAF	31
	BURGHIE ROTOPERCUTIE SDS-MAX ELICOIDALE - TCT	33
	BURGHIE ROTOPERCUTIE SDS-MAX ACCESORII	34
	BURGHIE ROTOPERCUTIE CAROTE	35
	BURGHIE ROTOPERCUTIE VARIA DRILLING SYSTEM	36
	ZIDARIE DRILL BITI	37
	BURGHIE UNIVERSALE PENTRU GAURIRE	39
	BURGHIE PENTRU GAURIT METAL HSS-R DIN 338 HSS-G DIN 338 HSS-CO DIN 338	41

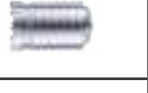
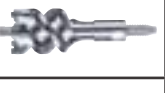
	BURGHIE PENTRU GAURIT TABLA	56
	BURGHIE COMBI PENTRU GAURIT	58
	BURGHIE CAROTA PENTRU METAL	59
	BURGHIE PENTRU LEMN CV	65
	BURGHIE ELICOIDALE PENTRU LEMN	67
	BURGHIE PLATE PENTRU LEMN	70
	BURGHIE PENTRU COFRAJE SI INSTALATII	73
	BURGHIE PENTRU GAURI LARGI IN LEMN	75
	CAROTE BI-METAL	77
	CAROTE PLACATE DIN CARBURA METALICA	81
	CAROTE DIAMANTATE PENTRU POLIZOARE UNGHIULARE	83
	CAROTE DIAMANTATE PENTRU MASINI DE GAURIT	84
	PADELE DE MIXARE	85
	MANDRINE	87
	DALTUIRE	91
	CAPETE PENTRU INSURUBARE CU IMPACT	99
	BITI & SETURI DE BITI	101
	TUBULARE PENTRU INSURUBARE CU IMPACT	107

	DISCURI DIAMANTATE	113
	DISCURI ABRAZIVE PENTRU DEBITARE SI SLEFUIRE	119
	DISCURI LAMELARE / FIBRE	124
	ACCESORII POLIZOARE UNGHIULARE	126
	FREZE DIN CARBURA METALICA	128
	PERII	133
	PANZE PENTRU FERASTRAIE CIRCULARE	137
	PANZE PENTRU FERASTRAIE PENDULARE	147
	PANZE PENTRU FERASTRAIE SABIE	153
	PANZE PENTRU FERASTRAIE CU BANDA	164
	ACCESORII MULTI TOOLS	165
	FREZE PENTRU ROUTERE	173
	CUTITE PENTRU RINDELE	179
	HARTIE PENTRU SLEFUIRE	180
	BONETE DE LANA	189
	POLISHARE	190
	ACCESORII PENTRU ASPIRATOARE	191
	ACCESORII PENTRU PISTOALE CU AER CALD	198
	BENZI CU SURUBURI	199

	CUIE, CAPSE & BUTELII	200
	ALTE ACCESORII	204

# PROLINE BURGHIE ROTOPERCUTIE SDS-PLUS



## Burghie pentru rotopercutie

Burghiele Hikoki pentru gaurire in beton sunt produse in Germania. Conceptia lor se realizeaza folosind cele mai avansate programe de calculator, luandu-se ca reper primordial cel mai înalt grad de eficienta si durabilitate. Dezvoltarea produselor este un proces continuu iar Compania Hikoki este în mod constant preocupata de îmbunatatirea calitatii lor. Este supusa dezvoltarii toata gama de accesorii, atât pentru ciocanele rotopercutoare cat si pentru ciocanele demolatoare, asigurand astfel calitate in operare indiferent de gama de operatiuni executate, luandu-se in calcul si bugetul utilizatorilor.

## Puterea de gaurire

Pentru gaurirea betonului Hikoki ofera cinci variante de burghie : SDS-plus, SDSmax, 13mm hexagonal, 19mm hexagonal si Spline. Toate aceste burghie se ridica la cele mai înalte standarde de eficienta si durata lunga de viata. Un nou standard este astfel stabilit, permitându-va - ca utilizator - sa beneficiati de usurinta in exploatare si de costuri mici pentru orice operatiune.

Capacitatea de penetrare, viteza de gaurire si durata de viata mare sunt caracteristicile care fac diferenta si confera masinii dumneavoastra randamentul maxim.







## Certificare PGM

Burghiele SDS Hikoki pentru ciocane rotopercutoare (exceptand gama basic) poarta marca de conformitate a Prüfgemeinschaft Mauerbohrer eV (PGM), ceea ce le face potrivite pentru instalarea si fixarea in conditii de maxima siguranta a elementelor de ancorare in beton sau zidarie. Tolerantele lor sunt adaptate la ancorele metalice, libere sau din plastic cu agrement tehnic european (ETA). Acest lucru nu este valabil pentru burghiele fara marca PGM. Utilizarea lor poate influenta siguranta si fiabilitatea fixarii ancorei. Burghiele cu acest semn sunt garantate si conforme cu criteriile stricte in ceea ce priveste diametrul varfului de carbura, lipit simetric si concentricitatea gaurilor. Cu aceste burghie care au aceasta certificare, utilizatorul va efectua gauri geometric precise, ancorarile sunt perfecte si astfel sunt garantate cele mai bune rezultate.



## SDS-Plus in patru modele

Hikoki a conceput o gama completa de burghie SDS-Plus, in trei niveluri diferite de calitate si pret, adaptata sa deserveasca orice tip de utilizator, de la utilizatorii profesionisti la cei ocazionali. Acestia pot decide ce calitate si nivel al preturilor li se potriveste cel mai bine. In graficul de mai jos puteti gasi o prezentare generala a avantajelor fiecarui grup de burghie si cele mai importante caracteristici.

	PROFI 4-MUCHII			PROFI 2-MUCHII	SEMI PROFI 2-MUCHII	BASIC 2-MUCHII
	5-10 mm	11-16 mm	18-32 mm	4-26 mm	4-16 mm	4-16 mm
Diametrul	5-10 mm	11-16 mm	18-32 mm	4-26 mm	4-16 mm	4-16 mm
Forma carburii metalice	 FCH					
Varf centrare carbura	da			da	nu	nu
Designul burghiului	multi spirala			multi spirala	standard	standard
Pentru armaturi metalice	recomandat			se preteaza	nu	nu
Precizia dimensiunilor	***			**	*	*
Viteza de gaurire	**			**	*	*
Durabilitate	***			**	*	*
Absorbția Vibratiilor	***			**	*	*
Puterea de transmisie	***			***	*	*
Produs in:	Germania			Germania	Germania	China
Marca PGM	da			da	da	nu
Greutatea masinii	2-4 kg			2-4 kg	2-4 kg	2-4 kg
Aplicatii	Potrivite pentru utilizatorii care au nevoie de un ciclu de viata lung si se confrunta cu lucrari in beton armat sau cu pietre in beton dur. Desi preturile de achizitie sunt mai mari, costurile pe gaura sunt mai mici.			Potrivite pentru utilizatori intermediari care doresc sa foloseasca ciocanul rotopercutor pe materiale cu duritate medie.	Potrivite pentru utilizatorul ocazional care acorda prioritate pretului de achizitie, in cazul in care durabilitatea si viteza de gaurire nu conteaza	Potrivite pentru utilizatorul ocazional pentru care pretul este cel mai important criteriu.

# PROLINE

## BURGHIE SDS-PLUS

### CAP INTEGRAL DIN CARBURA Ø 5 – 10 MM

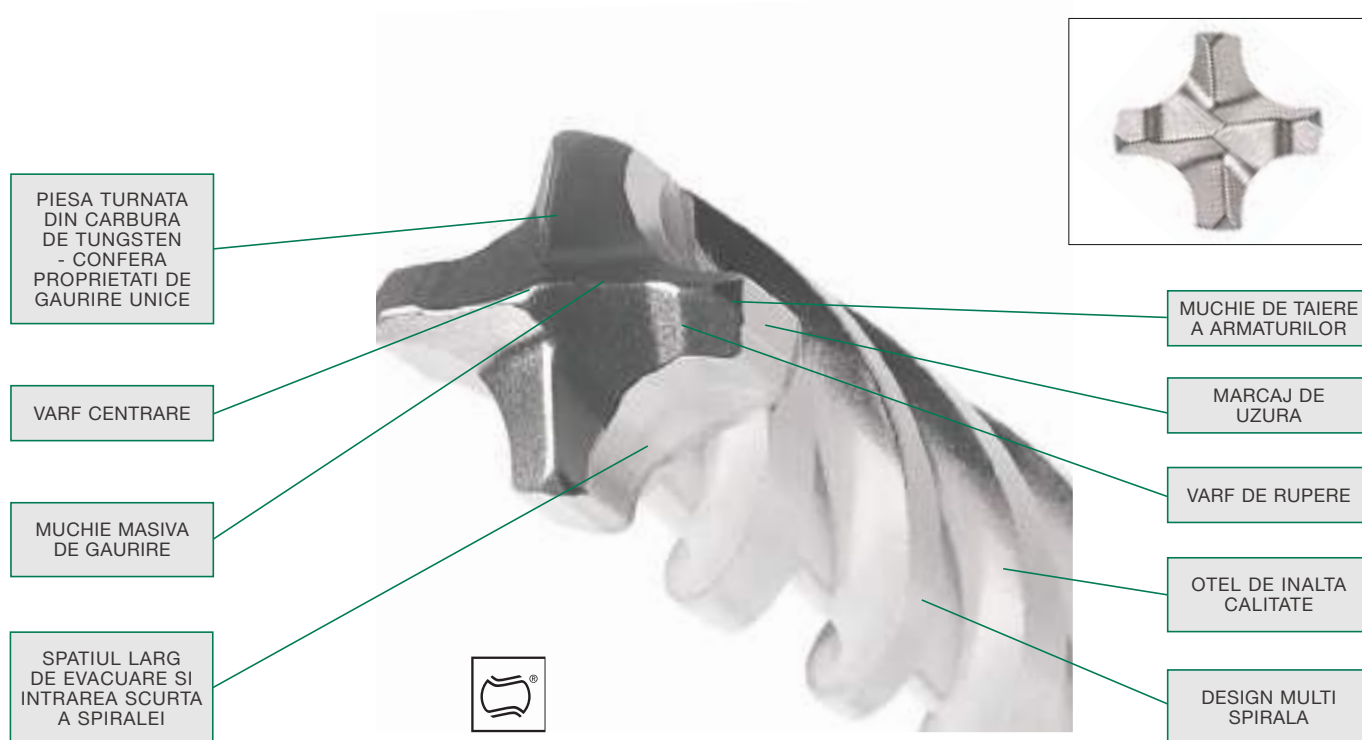

Dupa succesul mare al burghiului de gaurit cu rotopercutie SDS-Plus cu cap de carbura încorporat, Hikoki accelereaza acum tehnologia de gaurire prin introducerea burghiului SDS-Plus cu cap plin de carbura (FCH). Aceste burghie depasesc performantele modelului anterior în ceea ce priveste viteza de gaurire, gauri mai precise si o crestere semnificativa a durabilitatii în beton armat.

Acest lucru este realizat prin geometria capului nou dezvoltat si designului spiralei, designul FCH contine patru puncte dure la fiecare colt, ceea ce duce la o durata de viata crescuta si la un comportament optim de gaurire atunci când burghiul atinge armatura.

Cele doua muchii de rupere de pe marginea de taiere a carburilor asigura o rezistenta sporita a capului de carbura si o performanta îmbunatatita de penetrare în beton.

Capul de carbura cu marginea de taiere principala masiva si simetria sa de taiere de  $4 \times 90^\circ$  previne blocarea în cazul atingerii armaturii.

Geometria sa a fost dezvoltata pentru forte maxime de impact si torsiune, precum si pentru o durata de viata prelungita. Punctul de centrare ajuta la pozitionarea corecta a gaurii si împiedica ca acesta sa alunece peste suprafata.

Marcajul de uzura serveste drept indicator al preciziei si stabilitatii dimensiunii pentru gaurile de ancorare în conformitate cu PGM.

Noua geometrie a capului are un spatiu de evacuare marit la suprafata de taiere pentru a facilita o îndepartare usoara a resturilor. Forma scurta a spiralei face ca praful de foraj sa fie evacuat mai rapid.







La geometria cu 4 spirale latimea spiralei creste spre coada burghiului.

Partea ingusta dinspre capul burghiului reduce frictiunea în gaura si imbunatateste puterea de gaurire, în timp ce partea lata dinspre coada burghiului suporta forta de torsiune si reduce uzura. Combinatia optimizata a celor doua asigura o îndepartare mai rapida a prafului de foraj, asigurând în acelasi timp o gaurire cu vibratii reduse. Folosirea aliajului de otel de înalta calitate, în combinatie cu calirea speciala, lipirea si tratarea suprafetei, produce un burghiu profesional de înalta calitate, robust.







Acest burghiu complet nou proiectat are ca rezultat o capacitate de gaurire cu 25% mai rapida si o durata de viata mai mare cu 20% în comparatie cu burghiul din carbura incorporata cu 4 muchii.

În cazul în care utilizatorul loveste o armatura din beton, burghiul FCH asigura o rezistenta mai mare împotriva ruperii si o crestere a duratei de viata cu aproximativ 150%.









BURGHIE ROTOPERCUTIE SDS-PLUS TCT CU CAP TURNAT DIN CARBURA

 		Ø (mm)	Lungime totala (mm)	Lungime utila (mm)	PQ	MOQ	Cod comanda	Cod de bare
   		5	115	50	1	1	783201	8717574056112
		5	165	100	1	1	783202	8717574056129
		5	215	150	1	1	783203	8717574056136
		5	265	200	1	1	783204	8717574056143
		5	315	250	1	1	783205	8717574056150
		5,5	115	50	1	1	783206	8717574056167
		5,5	165	100	1	1	783207	8717574056174
		6	115	50	1	1	783208	8717574056181
		6	165	100	1	1	783209	8717574056198
		6	215	150	1	1	783210	8717574056204
		6	265	200	1	1	783211	8717574056211
		6	315	250	1	1	783212	8717574056228
		6,5	165	100	1	1	783214	8717574056242
		6,5	215	150	1	1	783215	8717574056259
		6,5	265	200	1	1	783216	8717574056266
		6,5	315	250	1	1	783217	8717574056273
		7	115	50	1	1	783218	8717574056280
		7	165	100	1	1	783219	8717574056297
		7	215	150	1	1	783220	8717574056303
		8	115	50	1	1	783221	8717574056310
		8	165	100	1	1	783222	8717574056327
		8	215	150	1	1	783223	8717574056334
		8	265	200	1	1	783224	8717574056341
		8	315	250	1	1	783225	8717574056358
		8	365	300	1	1	783226	8717574056365
		8	465	400	1	1	783227	8717574056372
		8	605	540	1	1	783228	8717574056389
		9	165	100	1	1	783229	8717574056396
		9	265	200	1	1	783230	8717574056402
		10	115	50	1	1	783231	8717574056419
		10	165	100	1	1	783232	8717574056426
		10	215	150	1	1	783233	8717574056433
		10	265	200	1	1	783234	8717574056440
	10	315	250	1	1	783235	8717574056457	
	10	365	300	1	1	783236	8717574056464	
	10	455	390	1	1	783237	8717574056471	
	10	600	540	1	1	783238	8717574056488	
	10	1000	940	1	1	783239	8717574056495	













BURGHIE ROTOPERCUTIE SDS-PLUS TCT CU CAP TURNAT DIN CARBURA PACHET AVANTAJ

  		Ø (mm)	Lungime totala (mm)	Lungime utila (mm)	PQ	MOQ	Cod comanda	Cod de bare
 	 	5	115	50	10	1	783301	8717574056990
		5	165	100	10	1	783302	8717574057003
		5,5	115	50	10	1	783303	8717574057010
		5,5	165	100	10	1	783304	8717574057027
		6	115	50	10	1	783305	8717574057034
		6	165	100	10	1	783306	8717574057041
		6	215	150	10	1	783307	8717574057058
		6	265	200	10	1	783308	8717574057065
		6	315	250	10	1	783309	8717574057072
		6,5	165	100	10	1	783310	8717574057089
		6,5	215	150	10	1	783311	8717574057096
		6,5	265	200	10	1	783312	8717574057102
		6,5	315	200	10	1	783313	8717574057119
		7	115	50	10	1	783314	8717574057126
		7	165	100	10	1	783315	8717574057133
		8	115	50	10	1	783316	8717574057140
		8	165	100	10	1	783317	8717574057157
		8	215	150	10	1	783318	8717574057164
		8	265	200	10	1	783319	8717574057171
		8	315	250	10	1	783320	8717574057188
	9	165	100	10	1	783321	8717574057195	
	9	265	200	10	1	783322	8717574057201	
	10	115	50	10	1	783323	8717574057218	
	10	165	100	10	1	783324	8717574057225	
	10	215	150	10	1	783325	8717574057232	
	10	265	200	10	1	783326	8717574057249	
	10	315	250	10	1	783327	8717574057256	

**BURGHIE ROTOPERCUTIE SDS-PLUS TCT CU CAP TURNAT DIN CARBURA PACHET AVANTAJ**

  		Ø (mm)	Lungime totala (mm)	Lungime utila (mm)	PQ	MOQ	Cod comanda	Cod de bare
   		5	115	50	25	1	783341	8717574057263
		5	165	100	25	1	783342	8717574057270
		5,5	115	50	25	1	783343	8717574057287
		5,5	165	100	25	1	783344	8717574057294
		6	115	50	25	1	783345	8717574057300
		6	165	100	25	1	783346	8717574057317
		6	215	150	25	1	783347	8717574057324
		6	265	200	25	1	783348	8717574057331
		6,5	165	100	25	1	783349	8717574057348
		6,5	215	150	25	1	783350	8717574057355
		6,5	265	200	25	1	783351	8717574057362
		7	115	50	25	1	783352	8717574057379
		7	165	100	25	1	783353	8717574057386
		8	115	50	25	1	783354	8717574057393
		8	165	100	25	1	783355	8717574057409
		8	215	150	25	1	783356	8717574057416
		8	265	200	25	1	783357	8717574057423
		8	315	250	25	1	783358	8717574057430
		9	165	100	25	1	783359	8717574057447
		9	265	200	25	1	783360	8717574057454
	10	115	50	25	1	783361	8717574057461	
	10	165	100	25	1	783362	8717574057478	
	10	215	150	25	1	783363	8717574057485	
	10	265	200	25	1	783364	8717574057492	
	10	315	250	25	1	783365	8717574057508	

**BURGHIE ROTOPERCUTIE SDS-PLUS TCT CU CAP TURNAT DIN CARBURA SETURI**

 		Continut	PQ	MOQ	Cod comanda	Cod de bare
   		4-Buc 6 x 165 mm 8 x 165 mm 10 x 165 mm 12 x 160 mm (4 muchii)	4	1	783390	8717574057515
						
 		7-Buc 5 x 115 mm 6 x 115 mm 8 x 115 mm 6 x 165 mm 8 x 165 mm 10 x 165 mm 12 x 160 mm (4 muchii)	7	1	783391	8717574057522
						

# PROLINE

## BURGHIE ROTOPERCUTIE

### SDS-PLUS 4-MUCHII Ø 11 - 16 MM

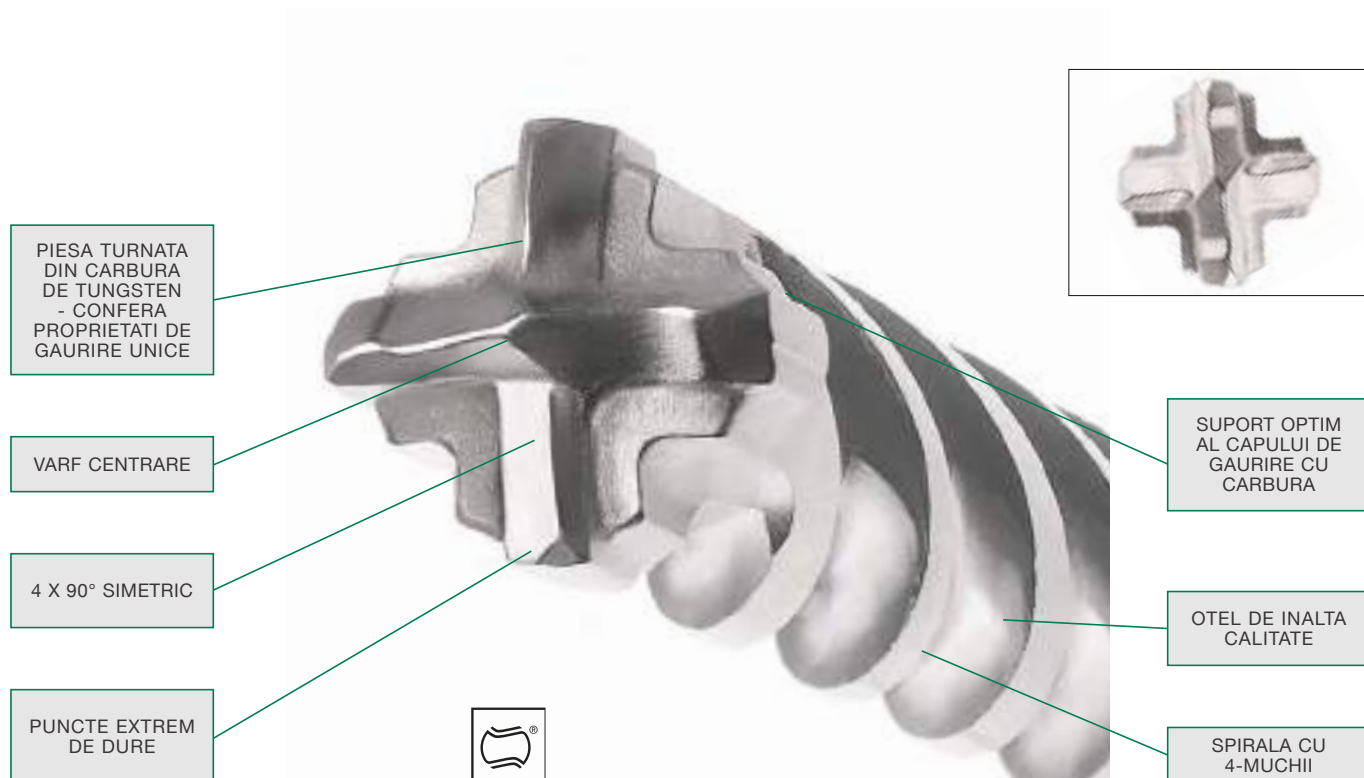

Burghiile SDS-Plus cu 4 muchii cu pastila incastrata Hikoki sunt concepute pentru utilizari foarte intense. Designul dinamic datorita caracteristicilor imbunatatite confera pe langa o durata de viata lunga si o viteza de penetrare mai mare si implicit mai mult confort in lucru.

Capul cu 4 muchii simetrice asigura o penetrare lina si fluida in material, rezultand astfel gauri perfect rotunde.





Geometria speciala a spiralei de evacuare cu 4-muchii asigura:

- Drenarea buna a locului gaurit
- Reduce vibratiile inutile
- Rezistenta mare la indoire
- Permite maximum de transmisie a puterii de la masina la burghiu
- Nivelul de zgomot este mult diminuat







Acest lucru duce la o durata de viata cu 50% mai mare in comparatie cu un burghiu conventional cu doua muchii. In cazul in care utilizatorul intalneste armatura betonului designul cu 4-muchii asigura un contact continuu si reduce sansa de a rupe capul burghiului. Geometria speciala a capului de taiere ofera suport optim pentru placutele din carbura metalica si absorbtie imbunatatita a fortelor de recul generate in timpul gauriri.



SDS-PLUS TCT BURGHIE ROTOPERCUTIE 4-MUCHII

 		Ø (mm)	Lungime totala (mm)	Lungime utila (mm)	PQ	MOQ	Cod comanda	Cod de bare
  	11	160	100	1	1	752732	8717574030495	
	11	210	150	1	1	752733	8717574030501	
	11	260	200	1	1	752734	8717574030518	
	11	310	250	1	1	752735	8717574030525	
	12	160	100	1	1	752772	8717574010251	
	12	210	150	1	1	752773	8717574010268	
	12	260	200	1	1	752774	8717574010275	
	12	310	250	1	1	752775	8717574010282	
	12	450	400	1	1	752776	8717574010299	
	12	600	550	1	1	752743	8717574023893	
	12	1000	950	1	1	752788	8717574017533	
	13	160	100	1	1	752736	8717574033762	
	13	210	150	1	1	752737	8717574033779	
	13	260	200	1	1	752738	8717574033786	
	13	310	250	1	1	752739	8717574033793	
	14	160	100	1	1	752777	8717574010305	
	14	210	150	1	1	752778	8717574010312	
	14	260	200	1	1	752785	8717574013214	
	14	310	250	1	1	752779	8717574010329	
	14	450	400	1	1	752780	8717574010336	
	14	600	550	1	1	752744	8717574023909	
	14	1000	950	1	1	752789	8717574017540	
	15	160	100	1	1	752745	8717574023916	
	15	210	160	1	1	752746	8717574023923	
	15	260	200	1	1	752747	8717574023930	
	15	450	400	1	1	752748	8717574023947	
	16	160	100	1	1	752791	8717574017557	
	16	210	150	1	1	752792	8717574017564	
	16	260	200	1	1	752793	8717574017571	
	16	310	250	1	1	752794	8717574017588	
	16	450	400	1	1	752795	8717574017595	
	16	600	550	1	1	752797	8717574023954	
16	1000	950	1	1	752796	8717574017601		

SDS-PLUS TCT BURGHIE ROTOPERCUTIE 4-MUCHII PACHET 10 BUCATI

  		Ø (mm)	Lungime totala (mm)	Lungime utila (mm)	PQ	MOQ	Cod comanda	Cod de bare
  	11	160	110	10	1	752926	8717574041637	
	11	210	160	10	1	752927	8717574041644	
	12	160	110	10	1	752928	8717574041651	
	12	210	160	10	1	752929	8717574041668	
	12	260	210	10	1	752930	8717574041675	
	12	310	260	10	1	752931	8717574041682	
	14	160	110	10	1	752932	8717574041699	
	14	210	160	10	1	752933	8717574041705	
	14	260	210	10	1	752934	8717574041712	
	14	310	260	10	1	752935	8717574041729	

# PROLINE

## BURGHIE ROTOPERCUTIE

### SDS-PLUS 4-MUCHII Ø 18 – 32 MM

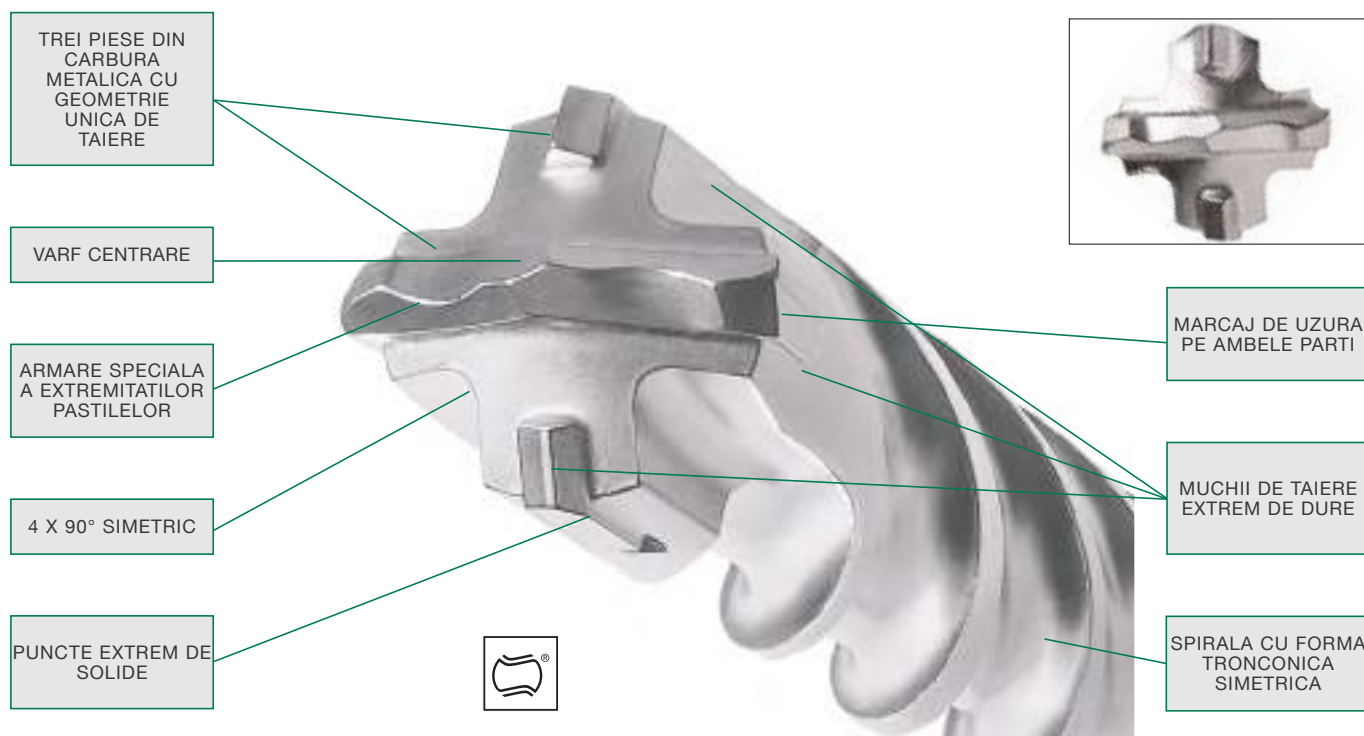



Urmarea dezvoltarii cu real succes a burghiilor SDS-Plus 4-muchii până la Ø16 mm este dezvoltarea burghiilor SDS-Plus cu dimensiuni mai mari. Aceasta se bazează pe specificatiile tehnice de baza pentru proiectarea burghiilor de dimensiuni mai

mici și care sunt perfecte pentru utilizatorii care operează în mod intensiv. Astfel sunt folosite aceleași caracteristici: capul de găurire cu 4 muchii tăietoare și spirala în 4 caneluri simetrice.

La această serie carbura de metal nu mai

este monobloc, geometria fiind asigurată de o pastilă centrală și două laterale dispuse la un unghi de 90 ° de o parte și de cealaltă.

SDS-PLUS TCT BURGHIE ROTOPERCUTIE 4-MUCHII

 	Ø (mm)	Lungime totala (mm)	Lungime utila (mm)	PQ	MOQ	Cod comanda	Cod de bare
	18	250	200	1	1	783273	8717574056839
	18	450	400	1	1	783274	8717574056846
	20	250	200	1	1	783275	8717574056853
	20	450	400	1	1	783276	8717574056860
	22	250	200	1	1	783277	8717574056877
	22	450	400	1	1	783278	8717574056884
	24	250	200	1	1	783279	8717574056891
	24	450	400	1	1	783280	8717574056907
	25	250	200	1	1	783281	8717574056914
	25	450	400	1	1	783282	8717574056921
	26	450	400	1	1	783283	8717574056938
	28	250	200	1	1	783284	8717574056945
	28	450	400	1	1	783285	8717574056952
	30	250	200	1	1	783286	8717574056969
	30	450	400	1	1	783287	8717574056976
	32	450	400	1	1	783288	8717574056983

# PROLINE

## BURGHIE ROTOPERCUTIE

### SDS-PLUS 2-MUCHII

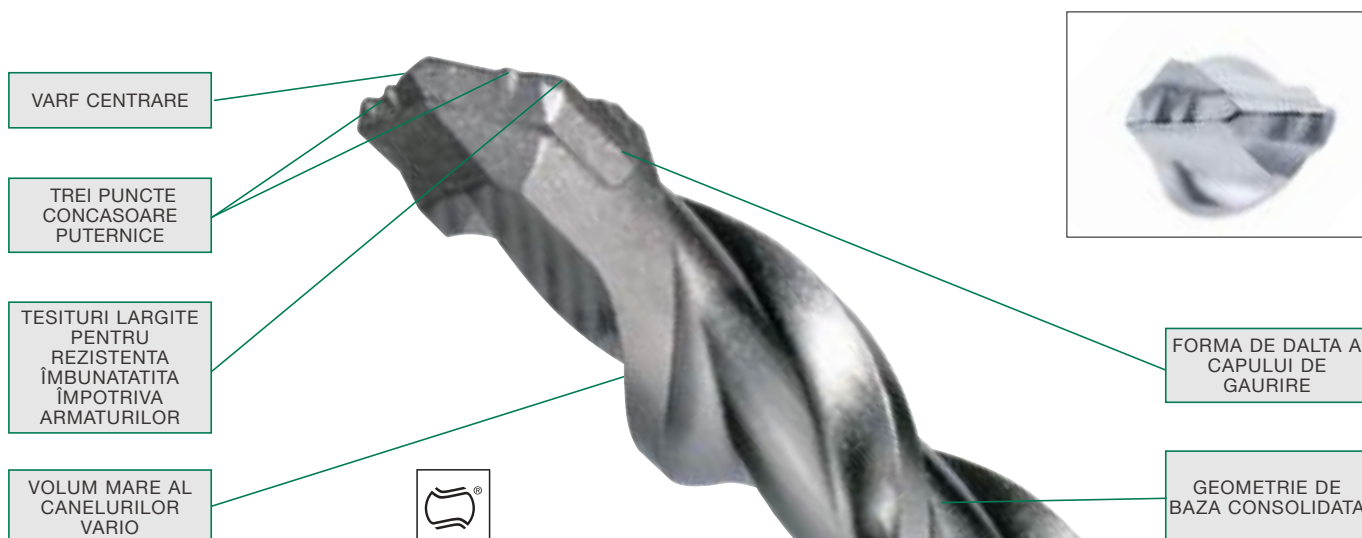

#### Gaurire la nivel superior

Burghiile SDS-Plus 2-muchii cu dubla spirala îndeplinesc cele mai înalte standarde de calitate și sunt concepute pentru utilizatorul final profesionist. Hikoki aduce cea mai recentă inovație cu un burghiu nou dezvoltat, care stabilește un nou standard. Aceste burghii sunt testate în condiții extreme și și-au dovedit calitatea în termeni de eficiență și performanță.

#### Spargerea betonului

Conceptul cu 2-muchii are la bază o pastilă centrală din carbura metalică care conferă caracteristici speciale și multiple avantaje. Punctul de centrare nou proiectat prelungit până la umerii cu secțiunile în cruce asigură un foraj rapid și la punct fix. Pe lângă varful placat din carbura, au fost adăugate trei așa-numite "power breakers"-spargătoare puternice. Astfel, puterea de impact este transferată de pe mașină pe suprafețe mai mici de beton atunci când forța punctuală este mult mai mare. Efectul de demolare

crează microfisuri în materialul forat, creând astfel o viteză de gaurire sensibil mai mare.

#### Transportul rezidurilor

După ce betonul este spart, rezidurile forajului sau praful trebuie să fie transportate în afara găurii. Datorită umărului conic al canelurilor vario, partea din față a burghiului are o capacitate mai mare de transport. Pe lângă evitarea exploziilor de praf sau de reducere a vitezei care s-ar fi produs prin înfundarea găurii, umărul conic reduce frecarea în gaură și îmbunătățește viteza de foraj. Partea din spate a burghiului este mult mai robustă și rigidă, spatele este mai lat. În primul rând, efectul pozitiv este transferul de energie îmbunătățit pentru un foraj mai rapid. În al doilea rând, pericolul de rupere este mai mic. Această spirală specială reduce, de asemenea, vibrațiile inutile; forajul este mai puțin solicitant atât pentru operator cât și pentru ciocanul rotopercutor cu care se operează.

#### Confruntarea cu armaturile

Oțelul din betonul armat nu mai reprezintă o problemă. Capul burghiului dinamic, în forma de dalta, penetrează rapid în material și simultan creează fluxuri de praf în spirala multi-canal. Având în vedere că tesiturile metalice ramforsate sunt marite cu aproximativ 35% în comparație cu modelul precedent, varful lateral acum mai protejat împotriva deteriorării în caz de lovire cu armaturile metalice. De asemenea, probabilitatea de blocare a burghiului este redusă, în special pe umerii laterali.

#### Viteza și durata de viață

Toate aceste îmbunătățiri tehnice fac ca viteza de gaurire să crească cu un procent de peste 12% mai mare față de vechea gamă de burghii SDS-Plus de la Hikoki: "Noul standard în performanță".

SDS-PLUS TCT BURGHIE ROTOPERCUTIE 2-MUCHII





 		Ø (mm)	Lungime totala (mm)	Lungime utila (mm)	PQ	MOQ	Cod comanda	Cod de bare
  		4	110	50	1	1	782401	8717574045116
		4	160	100	1	1	782402	8717574045123
		4,8	160	100	1	1	782403	8717574045130
		5	110	50	1	1	782404	8717574045147
		5	140	80	1	1	782405	8717574045154
		5	160	100	1	1	782406	8717574045161
		5	210	150	1	1	782407	8717574045178
		5	260	150	1	1	782408	8717574045185
		5	310	250	1	1	782409	8717574045192
		5,5	110	50	1	1	782410	8717574045208
		5,5	160	100	1	1	782411	8717574045215
		5,5	210	150	1	1	782412	8717574045222
		5,5	260	200	1	1	782413	8717574045239
		5,5	310	250	1	1	782414	8717574045246
		5,5	600	550	1	1	782540	8717574050189
		6	110	50	1	1	782415	8717574045253
		6	160	100	1	1	782416	8717574045260
		6	210	150	1	1	782417	8717574045277
		6	260	200	1	1	782418	8717574045284
		6	310	250	1	1	782419	8717574045291
		6	410	350	1	1	782420	8717574045307
		6	460	400	1	1	782421	8717574045314
		6,5	110	50	1	1	782422	8717574045321
		6,5	160	100	1	1	782423	8717574045338
		6,5	210	150	1	1	782424	8717574045345
		6,5	260	200	1	1	782425	8717574045352
		6,5	310	250	1	1	782426	8717574045369
		6,5	400	340	1	1	782427	8717574045376
		6,5	460	400	1	1	782428	8717574045383
		7	110	50	1	1	782429	8717574045390
		7	160	100	1	1	782430	8717574045406
		7	210	150	1	1	782431	8717574045413
		8	110	50	1	1	782432	8717574045420
		8	160	100	1	1	782433	8717574045437
		8	210	150	1	1	782434	8717574045444
	8	260	200	1	1	782435	8717574045451	
	8	310	250	1	1	782436	8717574045468	
	8	400	340	1	1	782437	8717574045475	
	8	460	400	1	1	782438	8717574045482	
	8	600	550	1	1	782439	8717574045499	
	8	1000	950	1	1	782440	8717574045505	
	9	160	100	1	1	782441	8717574045512	
	9	210	150	1	1	782442	8717574045529	
	9,5	160	100	1	1	782443	8717574045536	
	10	110	50	1	1	782444	8717574045543	
	10	160	100	1	1	782445	8717574045550	
	10	210	150	1	1	782446	8717574045567	
	10	260	200	1	1	782447	8717574045574	
	10	310	250	1	1	782448	8717574045581	
	10	350	300	1	1	782449	8717574045598	
	10	450	400	1	1	782450	8717574045604	
	10	600	550	1	1	782451	8717574045611	
	10	800	750	1	1	782452	8717574045628	
	10	1000	950	1	1	782453	8717574045635	

BURGHIE ROTOPERCUTIE







SDS-PLUS TCT BURGHIE ROTOPERCUTIE 2-MUCHII

 		Ø (mm)	Lungime totala (mm)	Lungime utila (mm)	PQ	MOQ	Cod comanda	Cod de bare
  	11	160	100	1	1	782454	8717574045642	
	11	210	150	1	1	782455	8717574045659	
	11	260	200	1	1	782456	8717574045666	
	11	310	250	1	1	782457	8717574045673	
	12	160	100	1	1	782458	8717574045680	
	12	210	150	1	1	782459	8717574045697	
	12	260	200	1	1	782460	8717574045703	
	12	310	250	1	1	782461	8717574045710	
	12	360	300	1	1	782462	8717574045727	
	12	450	400	1	1	782463	8717574045734	
	12	600	550	1	1	782464	8717574045741	
	12	800	750	1	1	782465	8717574045758	
	12	1000	950	1	1	782466	8717574045765	
	13	160	100	1	1	782467	8717574045772	
	13	210	150	1	1	782468	8717574045789	
	13	260	200	1	1	782469	8717574045796	
	13	310	250	1	1	782470	8717574045802	
	14	160	100	1	1	782471	8717574045819	
	14	210	150	1	1	782472	8717574045826	
	14	260	200	1	1	782473	8717574045833	
	14	310	250	1	1	782474	8717574045840	
	14	450	400	1	1	782475	8717574045857	
	14	600	550	1	1	782476	8717574045864	
	14	800	750	1	1	782477	8717574045871	
	14	1000	950	1	1	782478	8717574045888	
	15	160	100	1	1	782479	8717574045895	
	15	210	150	1	1	782480	8717574045901	
	15	260	200	1	1	782481	8717574045918	
	15	450	400	1	1	782482	8717574045925	
	16	160	100	1	1	782483	8717574045932	
	16	210	150	1	1	782484	8717574045949	
	16	260	200	1	1	782485	8717574045956	
	16	310	260	1	1	782486	8717574045963	
	16	450	400	1	1	782487	8717574045970	
16	600	550	1	1	782488	8717574045987		
16	800	750	1	1	782489	8717574045994		
16	1000	950	1	1	782490	8717574046007		
17	210	150	1	1	782491	8717574046014		
18	200	150	1	1	782492	8717574046021		
18	250	200	1	1	782493	8717574046038		
18	300	250	1	1	782494	8717574046045		
18	450	400	1	1	782495	8717574046052		
18	600	550	1	1	782496	8717574046069		
18	1000	950	1	1	782497	8717574046076		
19	200	150	1	1	782498	8717574046083		
19	450	400	1	1	782499	8717574046090		
20	200	150	1	1	782500	8717574046106		
20	250	200	1	1	782501	8717574046113		
20	300	250	1	1	782502	8717574046120		
20	450	400	1	1	782503	8717574046137		
20	600	550	1	1	782504	8717574046144		
20	1000	950	1	1	782505	8717574046151		

**SDS-PLUS TCT BURGHIE ROTOPERCUTIE 2-MUCHII**







 		Ø (mm)	Lungime totala (mm)	Lungime utila (mm)	PQ	MOQ	Cod comanda	Cod de bare
  		22	250	200	1	1	782506	8717574046168
		22	300	250	1	1	782507	8717574046175
		22	450	400	1	1	782508	8717574046182
		22	600	550	1	1	782509	8717574046199
		22	1000	950	1	1	782510	8717574046205
		23	250	200	1	1	782511	8717574046212
		23	450	400	1	1	782512	8717574046229
		24	250	200	1	1	782513	8717574046236
		24	300	250	1	1	782514	8717574046243
		24	450	400	1	1	782515	8717574046250
		25	250	200	1	1	782516	8717574046267
		25	300	250	1	1	782517	8717574046274
		25	450	400	1	1	782518	8717574046281
		25	600	550	1	1	782519	8717574046298
		25	1000	950	1	1	782520	8717574046304
		26	250	200	1	1	782521	8717574046311
		26	450	400	1	1	782522	8717574046328

**SDS-PLUS TCT 2-MUCHII BURGHIE ROTOPERCUTIE PACHET 10 BUCATI**







  		Ø (mm)	Lungime totala (mm)	Lungime utila (mm)	PQ	MOQ	Cod comanda	Cod de bare
  		4	110	50	10	1	782601	8717574046335
		4	160	100	10	1	782602	8717574046342
		5	110	50	10	1	782603	8717574046359
		5	140	80	10	1	782604	8717574046366
		5	160	100	10	1	782605	8717574046373
		5	210	150	10	1	782606	8717574046380
		5	260	200	10	1	782607	8717574046397
		5	310	250	10	1	782608	8717574046403
		5,5	110	50	10	1	782609	8717574046410
		5,5	160	100	10	1	782610	8717574046427
		5,5	210	150	10	1	782611	8717574046434
		5,5	260	200	10	1	782612	8717574046441
		6	110	50	10	1	782613	8717574046458
		6	160	100	10	1	782614	8717574046465
		6	210	150	10	1	782615	8717574046472
		6	260	200	10	1	782616	8717574046489
		6	310	250	10	1	782617	8717574046496
		6,5	110	50	10	1	782618	8717574046502
		6,5	160	100	10	1	782619	8717574046519
		6,5	210	150	10	1	782620	8717574046526
		6,5	260	200	10	1	782621	8717574046533
		6,5	310	250	10	1	782622	8717574046540
		7	110	50	10	1	782623	8717574046557
		7	160	100	10	1	782624	8717574046564
		7	210	150	10	1	782625	8717574046571
		8	110	50	10	1	782626	8717574046588
		8	160	100	10	1	782627	8717574046595
		8	210	150	10	1	782628	8717574046601
		8	260	200	10	1	782629	8717574046618
		8	310	250	10	1	782630	8717574046625



SDS-PLUS TCT 2-MUCHII BURGHIE ROTOPERCUTIE PACHET 10 BUCATI

  			Ø (mm)	Lungime totala (mm)	Lungime utila (mm)	PQ	MOQ	Cod comanda	Cod de bare
  	9	160	100	10	1	782631	8717574046632		
	9	210	150	10	1	782632	8717574046649		
	9,5	160	100	10	1	782633	8717574046656		
	10	110	50	10	1	782634	8717574046663		
	10	160	100	10	1	782635	8717574046670		
	10	210	150	10	1	782636	8717574046687		
	10	260	200	10	1	782637	8717574046694		
	10	310	250	10	1	782638	8717574046700		
	11	160	100	10	1	782639	8717574046717		
	11	210	150	10	1	782640	8717574046724		
	11	260	200	10	1	782641	8717574046731		
	11	310	250	10	1	782642	8717574046748		
	12	160	110	10	1	782643	8717574046755		
	12	210	160	10	1	782644	8717574046762		
	12	260	210	10	1	782645	8717574046779		
12	310	260	10	1	782646	8717574046786			

SDS-PLUS TCT 2-MUCHII BURGHIE ROTOPERCUTIE PACHET 25 BUCATI

  			Ø (mm)	Lungime totala (mm)	Lungime utila (mm)	PQ	MOQ	Cod comanda	Cod de bare
  	4	110	50	25	1	782651	8717574046793		
	4	160	100	25	1	782652	8717574046809		
	5	110	50	25	1	782653	8717574046816		
	5	140	80	25	1	782654	8717574046823		
	5	160	100	25	1	782655	8717574046830		
	5	210	150	25	1	782656	8717574046847		
	5	260	200	25	1	782657	8717574046854		
	5,5	110	50	25	1	782658	8717574046861		
	5,5	160	100	25	1	782659	8717574046878		
	5,5	210	150	25	1	782660	8717574046885		
	5,5	260	200	25	1	782661	8717574046892		
	6	110	50	25	1	782662	8717574046908		
	6	160	100	25	1	782663	8717574046915		
	6	210	150	25	1	782664	8717574046922		
	6	260	200	25	1	782665	8717574046939		
	6,5	110	50	25	1	782666	8717574046946		
	6,5	160	100	25	1	782667	8717574046953		
	6,5	210	150	25	1	782668	8717574046960		
	6,5	260	200	25	1	782669	8717574046977		
	7	110	50	25	1	782670	8717574046984		
	7	160	100	25	1	782671	8717574046991		
	7	210	150	25	1	782672	8717574047004		
	8	110	50	25	1	782673	8717574047011		
	8	160	100	25	1	782674	8717574047028		
	8	210	150	25	1	782675	8717574047035		
8	260	200	25	1	782676	8717574047042			
9	160	100	25	1	782677	8717574047059			
9	210	150	25	1	782678	8717574047066			
10	110	50	25	1	782679	8717574047073			
10	160	100	25	1	782680	8717574047080			
10	210	150	25	1	782681	8717574047097			

BURGHIE ROTOPERCUTIE SDS-PLUS TCT SETURI

		Continut	PQ	MOQ	Cod comanda	Cod de bare
  		5-Buc 5 x 110 mm 6 x 110 mm 8 x 110 mm 6 x 160 mm 8 x 160 mm	5	1	782530	8717574047165
		5-Buc 5 x 160 mm 6 x 160 mm 8 x 160 mm 10 x 160 mm 12 x 160 mm	5	1	782531	8717574047172
		5-Buc 6 x 110 mm 8 x 110 mm 6 x 160 mm 8 x 160 mm 10 x 160 mm	5	1	782532	8717574047189
		5-Buc 10 x 450 mm 12 x 450 mm 14 x 450 mm 16 x 450 mm 20 x 450 mm	5	1	782534	8717574052572
		6-Buc 10 x 450 mm 12 x 450 mm 14 x 450 mm 16 x 450 mm 18 x 450 mm 20 x 450 mm	6	1	782533	8717574047196
		6-Buc Mandrina de 13 mm cu adaptor SDS-Plus 5 x 110 mm 6 x 110 mm 8 x 110 mm 6 x 160 mm 8 x 160 mm	6	1	751025	8717154657449
		6-Buc Mandrina rapida de 13 mm cu adaptor SDS-Plus 5 x 110 mm 6 x 110 mm 8 x 110 mm 6 x 160 mm 8 x 160 mm	6	1	751030	8717472816580

BURGHIE ROTOPERCUTIE



# PROLINE

## BURGHIE ROTOPERCUTIE

### SDS-PLUS SEMI PROFESIONALE

CAPUL BURHIULUI  
ARE FORMA DE  
DALTA

VÂRF DE CARBURA  
SOLID CU  
UNGHII DE 130 °

SPIRALA DE  
TRANSPORT ESTE  
LARGA



REZISTENTA MARE  
LA INDOIRE







Burghiul SDS-Plus Semi profesional este pentru utilizare în beton, zidarie și piatră naturală. Acest burghiu este rentabil datorită faptului că este rapid, dinamic și varful este robust și acoperit din carbura metalică.

Transportul rezidurilor se realizează ușor, acest lucru datorându-se spiralelor largi. Este foarte apreciat pentru calitatea sa mai mult decât rezonabilă de către utilizatorii ocazionali, care acordă prioritate prețului

de achiziție în situația în care durabilitatea și viteza de tăiere sunt mai puțin importante sau chiar irelevante.

SDS-PLUS SEMI PROFESIONALE BURGHIE ROTOPERCUTIE 2-MUCHII

 		Ø (mm)	Lungime totala (mm)	Lungime utila (mm)	PQ	MOQ	Cod comanda	Cod de bare
  	4	110	50	1	1	750371	8717574034103	
	4	160	100	1	1	750372	8717574034110	
	5	110	50	1	1	750373	8717574034127	
	5	160	100	1	1	750374	8717574034134	
	5,5	110	50	1	1	750375	8717574034141	
	5,5	160	100	1	1	750376	8717574034158	
	6	110	50	1	1	750377	8717574034165	
	6	160	100	1	1	750378	8717574034172	
	6	210	150	1	1	750379	8717574034189	
	7	160	100	1	1	750380	8717574034196	
	8	110	50	1	1	750381	8717574034202	
	8	160	100	1	1	750382	8717574034219	
	8	210	150	1	1	750383	8717574034226	
	8	260	200	1	1	750384	8717574034233	
	10	160	100	1	1	750385	8717574034240	
	10	210	150	1	1	750386	8717574034257	
	10	260	200	1	1	750387	8717574034264	
	12	160	100	1	1	750388	8717574034271	
	12	210	150	1	1	750389	8717574034288	
	12	260	200	1	1	750390	8717574034295	
14	160	100	1	1	750391	8717574034301		
14	210	150	1	1	750392	8717574034318		
14	260	200	1	1	750393	8717574034325		
16	160	100	1	1	750394	8717574034332		
16	210	150	1	1	750395	8717574034349		

# PROLINE

## BURGHIE ROTOPERCUTIE

### SDS-PLUS BASIC





Linia SDS-Plus Basic este reprezentata de burghie de nivel entry-level (incepator) adecvate pentru utilizatorul ocazional.





Preturile atractive au o importanta mai mare decat durata de viata a burghiului datorita numarului redus de gauri pe care acest uti-

lizator ocazional le va executa. Sunt destinate utilizarii în zidarie si beton, nearmat.

SDS-PLUS BASIC BURGHIE ROTOPERCUTIE 2-MUCHII









	Ø (mm)	Lungime totala (mm)	Lungime utila (mm)	PQ	MOQ	Cod comanda	Cod de bare
	4	110	41	1	1	4100801	8717574063080
	4	160	91	1	1	4100802	8717574063097
	5	110	41	1	1	4100803	8717574063103
	5	160	91	1	1	4100804	8717574063110
	5,5	110	41	1	1	4100805	8717574063127
	5,5	160	91	1	1	4100806	8717574063134
	6	110	41	1	1	4100807	8717574063141
	6	160	91	1	1	4100808	8717574063158
	6	210	140	1	1	4100809	8717574063165
	6,5	110	41	1	1	4100810	8717574063172
	6,5	160	91	1	1	4100811	8717574063189
	7	110	41	1	1	4100812	8717574063196
	7	160	91	1	1	4100813	8717574063202
	8	110	41	1	1	4100814	8717574063219
	8	160	91	1	1	4100815	8717574063226
	8	210	140	1	1	4100816	8717574063233
	8	260	185	1	1	4100817	8717574063240
	10	160	91	1	1	4100818	8717574063257
	10	210	140	1	1	4100819	8717574063264
	10	260	185	1	1	4100820	8717574063271
	10	460	365	1	1	4100821	8717574063288
	12	160	91	1	1	4100822	8717574063295
	12	210	140	1	1	4100823	8717574063301
	12	260	185	1	1	4100824	8717574063318
12	460	365	1	1	4100825	8717574063325	
14	160	85	1	1	4100826	8717574063332	
14	210	130	1	1	4100827	8717574063349	
14	260	175	1	1	4100828	8717574063356	
14	460	365	1	1	4100829	8717574063363	
16	160	85	1	1	4100830	8717574063370	
16	210	130	1	1	4100831	8717574063387	
16	460	365	1	1	4100832	8717574063394	

BURGHIE ROTOPERCUTIE SDS-PLUS BASIC 2-MUCHII SETURI

	Ø (mm)	Lungime totala (mm)	Lungime utila (mm)	PQ	MOQ	Cod comanda	Cod de bare
 	5-Buc 5 x 110 mm 6 x 110 mm 8 x 160 mm 10 x 160 mm 12 x 160 mm			5	1	4100840	8717574063400
	17-Buc 5 x 110 mm 6 x 110 mm 6 x 160 mm 8 x 110 mm 8 x 160 mm 8 x 210 mm 10 x 110 mm 10 x 160 mm 10 x 210 mm 12 x 160 mm 12 x 260 mm 14 x 260 mm Spitz L = 140 mm Spitz L = 250 mm Delta lata 20 x 140 mm Delta lata 20 x 250 mm Delta lata 40 x 250 mm			17	1	402555	4549115081345

# PROLINE

## ACCESORII SDS-PLUS

ACCESORII SDS-PLUS					
	Descriere	PQ	MOQ	Cod comanda	Cod de bare
<b>ADAPTOARE DE LA SDS-PLUS:</b>					
	La 1/2" x 20 UNF filet exterior la M6 filet interior pentru mandrina	1	1	744085	8717154656039
	La 1/2" x 20 UNF filet exterior pentru mandrina si 1/4" hexagon interior pentru biti	1	1	744088	8717154659184
	La 1/4" hexagon interior pentru biti fara magnet	1	1	752388	8717574017397
	La 1/4" hexagon interior pentru biti cu magnet	1	1	752389	8717574017403
	La 1/2" cheie cu impact patrata	1	1	750455	8717574023862
<b>ADAPTOARE LA SDS-PLUS:</b>					
	De la SDS-Max	1	1	751006	8717154652772
	De la Spline	1	1	750200	8717154651539
	De la 13 mm hexagonal	1	1	750246	8717154651997





# PROLINE BURGHIE ROTOPERCUTIE SDS-MAX

## SDS-Max in trei game

Cea mai recenta generatie de burghie SDS MAX Hikoki, sunt unelte robuste si puternice, o combinatie inovatoare a geometriilor noi si preexistente ce ofera o calitate a gaurilor fara precedent. Acesta inseamna o viata extra-lunga, o mare precizie a gaurii

si transfer maxim de energie, chiar si în materiale extrem de dure. Confera o înalta performanta in gaurire pentru toti utilizatorii profesionisti care au nevoie de operare în beton armat si piatra.

Burghiile SDS-Max sunt disponibile pe trei niveluri de calitate: linia completa cu 4-muchii, linia de top cu 2-muchii cu diametre de 12 – 15 mm si linia restransa a gamei semi-profesionale.

	PROFESIONAL			SEMI PROFI
	4-MUCHII Ø 12 - 15 mm	4-MUCHII Ø 16 - 52 mm	2-MUCHII Ø 12 - 15 mm	2-MUCHII Ø 14 - 40 mm
<b>Forma carburii metalice</b>				
<b>Varf de centrare carbura</b>	da	da	da	nu
<b>Designul spiralei</b>	4-spirale	4-spirale	multi spirala	standard
<b>Pentru armaturi metalice</b>	recomandat	recomandat	se preteaza	nu
<b>Precizia dimensiunilor</b>	***	***	**	*
<b>Viteza de gaurire</b>	**	**	***	*
<b>Durabilitate</b>	***	***	**	*
<b>Absorbția vibrațiilor</b>	***	***	**	*
<b>Puterea de transmisie</b>	***	***	***	*
<b>PGM approved</b>	da	da	da	da
<b>Utilizare cu masini de</b>	2-4 kg	5-10 kg	5-10 kg	4-8 kg
<b>Aplicatii</b>	Potrivite pentru utilizatorii care au nevoie de un ciclu de viata lung si se confrunta cu lucrari in beton armat sau cu pietre in beton dur. Desi preturile de achizitie sunt mai mari, costurile pe gaura sunt mai mici.	Potrivite pentru utilizatorii care au nevoie de un ciclu de viata lung si se confrunta cu lucrari in beton armat sau cu pietre in beton dur. Desi preturile de achizitie sunt mai mari, costurile pe gaura sunt mai mici.	Potrivit pentru utilizatorul intermediar, care doreste sa foloseasca burghiul pentru a gaurii materiale cu duritate medie.	Potrivite pentru utilizatorul ocazional care acorda prioritate pretului de achizitie, in cazul in care durabilitatea si viteza de gaurire sunt mai putin importante sau irelevante.

# PROLINE

## BURGHIE ROTOPERCUTIE

### SDS-MAX 4-MUCHII Ø 12 – 15 MM

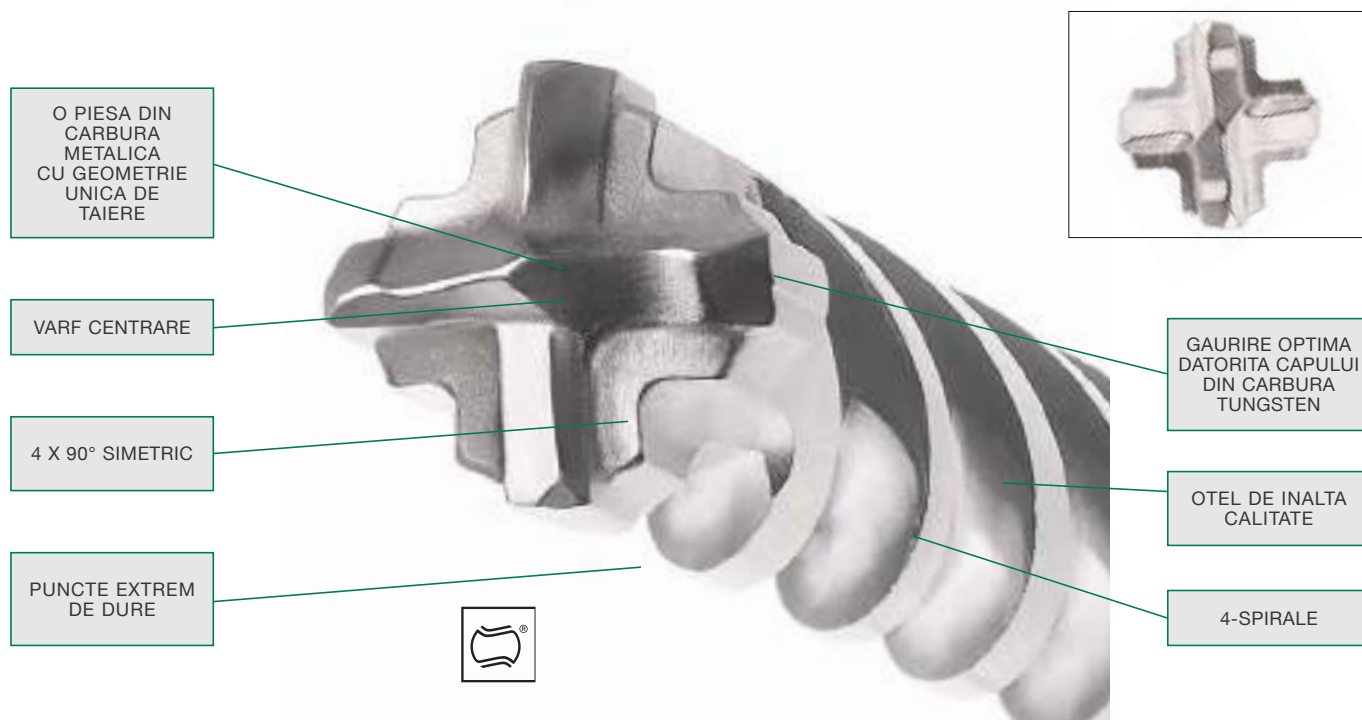

Ultima generatie de burghie SDS-Max cu 4 muchii Hikoki sunt concepute pentru utilizari foarte intense. Designul dinamic datorita caracteristicilor imbunatatite confera pe langa o durata de viata lunga si o viteza de penetrare mai mare si implicit mai mult confort in lucru.

Capul cu 4 muchii simetrice asigura o penetrare lina si fluida in material, rezultand astfel gauri perfect rotunde.













Geometria speciala a spiralei de evacuare cu 4-muchii asigura:

- Drenarea buna a locului gaurit
- Reduce vibratiile inutile
- Rezistenta mare la indoire
- Permite maximum de transmisie a puterii de la masina la burghiu
- Nivelul de zgomot este mult diminuat

Acest lucru duce la o durata de viata cu 50% mai mare in comparatie cu un burghiu conventional cu doua muchii.

In cazul in care utilizatorul intalneste armatura betonului designul cu 4-muchii asigura un contact continuu si reduce sansa de a rupe capul burghiului. Geometria speciala a capului de taiere ofera suport optim pentru placutele din carbura metalica si absorbtie imbunatatita a fortelor de recul generate in timpul gauririi.

SDS-MAX TCT BURGHIE ROTOPERCUTIE 4-MUCHII 12 - 15 MM

 		Ø (mm)	Lungime totala (mm)	Lungime utila (mm)	PQ	MOQ	Cod comanda	Cod de bare
  		12	340	200	1	1	754363	8717574049602
		12	540	400	1	1	754364	8717574049619
		12	740	600	1	1	754365	8717574049626
		12	940	800	1	1	754366	8717574049633
		14	340	200	1	1	754367	8717574049640
		14	540	400	1	1	754368	8717574049657
		15	340	200	1	1	754369	8717574049664
		15	540	400	1	1	754370	8717574049671

# PROLINE

## BURGHIE ROTOPERCUTIE

### SDS-MAX 4-MUCHII Ø 16 – 52 MM

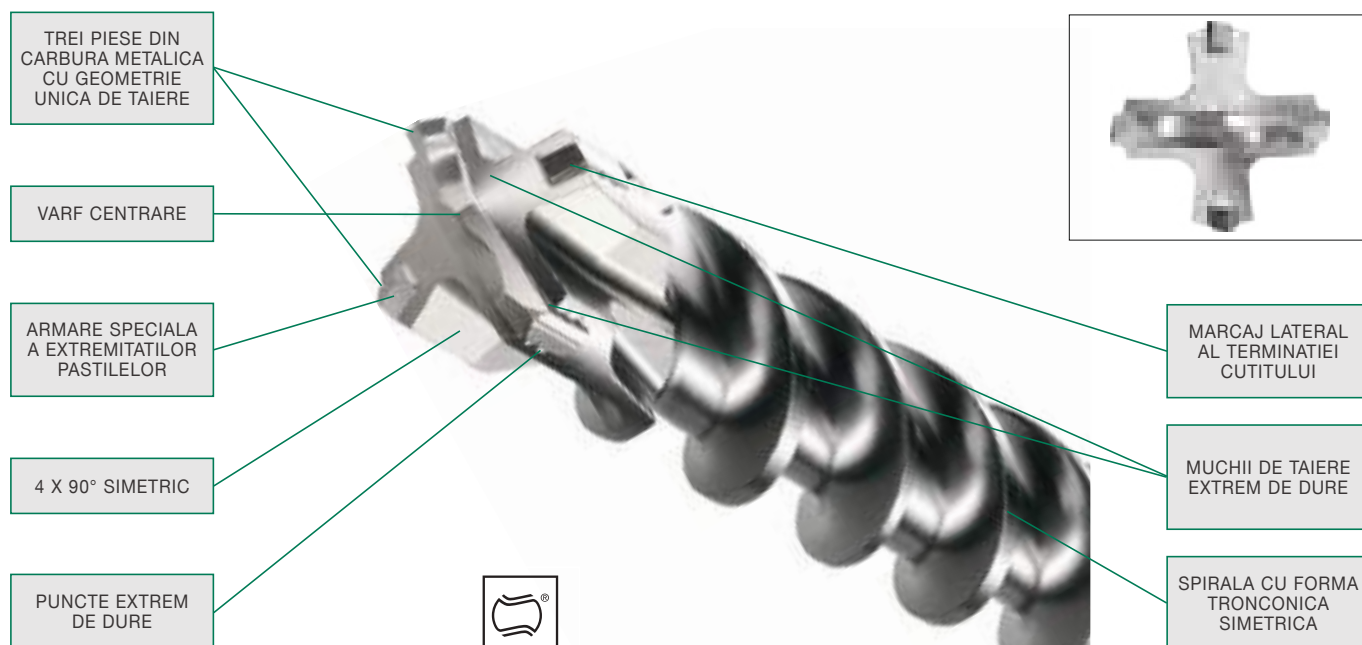

Burghiul Hikoki SDS-Max 4-muchii este un burghiu profesional robust conceput pentru performante excelente si cu o calitate fara compromisuri. În aceasta serie de burghie capului taietor este format dintr-o placa principala si alte doua placi laterale metalice dure intr-un unghi de 90 °.

Acest design deosebit previne blocarea burghiului in armatura, asta datorita dintilor





taietori secundari care ajuta în mod activ pastila principala in timpul gauririi. O caracteristica suplimentara a designului pastilelor este marказul uzurii cere este un indicator pentru evaluarea stabilitatii dimensionale a gaurilor de ancorare.

Datorita ramforsarii optime a inimii spiralei, este asigurata rezistenta mare la rupere a burghiului. Mai mult decat atat, energia de





impact este transferata direct la capul de foraj, si, în acelasi timp, praful este eliminat rapid pentru a obtine un progres constant in material.

In concluzie, acest tip de burghiu defineste raportul optim între viteza, durabilitate si performanta la nivel profesional.

SDS-MAX TCT BURGHIE ROTOPERCUTIE 4-MUCHII 16 - 18 MM

 		Ø (mm)	Lungime totala (mm)	Lungime utila (mm)	PQ	MOQ	Cod comanda	Cod de bare
  	16	340	200	1	1	754301	8717574026443	
	16	540	400	1	1	754302	8717574026450	
	16	740	600	1	1	754353	8717574029178	
	16	940	800	1	1	754303	8717574026467	
	16	1320	1200	1	1	754304	8717574026474	
	18	340	200	1	1	754305	8717574026481	
	18	540	400	1	1	754306	8717574026498	
	18	740	600	1	1	754354	8717574029185	
	18	940	800	1	1	754307	8717574026504	
	18	1320	1200	1	1	754308	8717574026511	

SDS-MAX TCT BURGHIE ROTOPERCUTIE 4-MUCHII 20 - 52 MM

 		Ø (mm)	Lungime totala (mm)	Lungime utila (mm)	PQ	MOQ	Cod comanda	Cod de bare
  	20	320	200	1	1	754309	8717574026528	
	20	520	400	1	1	754310	8717574026535	
	20	720	600	1	1	754355	8717574029192	
	20	920	800	1	1	754311	8717574026542	
	20	1320	1200	1	1	754312	8717574026559	
	22	320	200	1	1	754313	8717574026566	
	22	520	400	1	1	754314	8717574026573	
	22	720	600	1	1	754356	8717574029208	
	22	920	800	1	1	754315	8717574026580	
	22	1320	1200	1	1	754316	8717574026597	
	24	320	200	1	1	754317	8717574026603	
	24	520	400	1	1	754318	8717574026610	
	25	320	200	1	1	754319	8717574026627	
	25	520	400	1	1	754320	8717574026634	
	25	720	600	1	1	754357	8717574029215	
	25	920	800	1	1	754321	8717574026641	
	25	1320	1200	1	1	754322	8717574026658	
	26	520	400	1	1	754323	8717574026665	
	28	370	250	1	1	754324	8717574026672	
	28	570	450	1	1	754325	8717574026689	
	28	670	550	1	1	754326	8717574026696	
	28	920	800	1	1	754327	8717574026702	
	28	1320	1200	1	1	754328	8717574026719	
	30	370	250	1	1	754329	8717574026726	
	30	570	450	1	1	754330	8717574026733	
	30	720	600	1	1	754358	8717574029222	
	30	920	800	1	1	754331	8717574026740	
	32	370	250	1	1	754332	8717574026757	
	32	570	450	1	1	754333	8717574026764	
	32	720	600	1	1	754359	8717574029239	
	32	920	800	1	1	754334	8717574026771	
	32	1320	1200	1	1	754335	8717574026788	
	35	370	250	1	1	754336	8717574026795	
	35	570	450	1	1	754337	8717574026801	
	35	670	550	1	1	754338	8717574026818	
35	920	800	1	1	754339	8717574026825		
35	1320	1200	1	1	754360	8717574029246		
37	370	250	1	1	754340	8717574026832		
37	570	450	1	1	754341	8717574026849		
37	920	800	1	1	754342	8717574026856		
38	370	250	1	1	754343	8717574026863		
38	570	450	1	1	754344	8717574026870		
38	720	600	1	1	754361	8717574029253		
40	370	250	1	1	754345	8717574026887		
40	570	450	1	1	754346	8717574026894		
40	720	600	1	1	754362	8717574029260		
40	920	800	1	1	754347	8717574026900		
40	1320	1200	1	1	754348	8717574026917		
45	570	450	1	1	754349	8717574026924		
45	920	800	1	1	754350	8717574026931		
50	570	450	1	1	754351	8717574026948		
52	570	450	1	1	754352	8717574026955		



# PROLINE

## BURGHIE ROTOPERCUTIE

### SDS-MAX 2-MUCHII Ø 12 – 15 MM

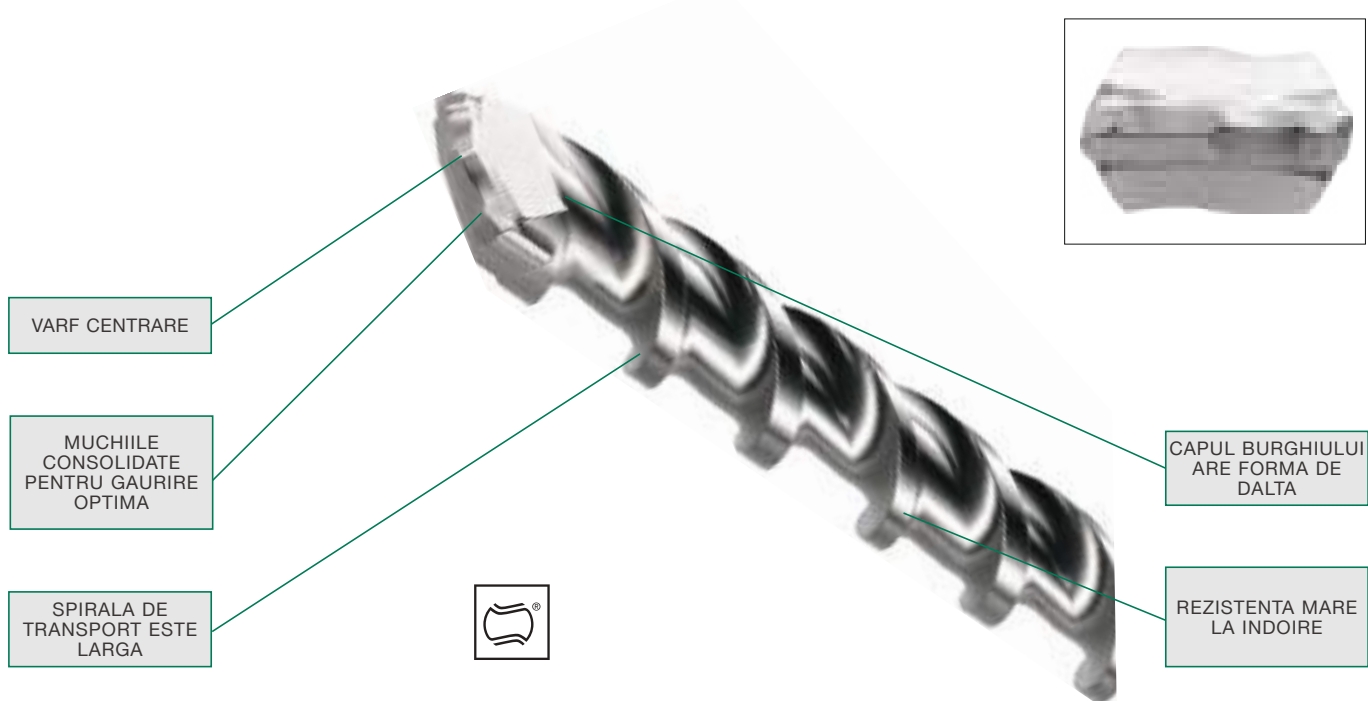





Burghiile SDS-Max 2-muchii cu spirala dubla satisfac cele mai înalte standarde de calitate și sunt concepute pentru utilizatorul profesionist. Acestea sunt testate în condiții extreme și au impus noi standarde în termeni de eficiență și performanță. Conceptul cu 2-muchii are la bază o placuță centrală din carbura metalică care conferă o centrare mai ușoară și o gaurire mai rapidă încă de la prima pornire. Viteza

de tăiere este cu aproximativ 25% mai mare decât standardul burghiilor SDSMax, cu o creștere a duratei de viață cu aproximativ 50%. Oțelul din betonul armat nu mai reprezintă o problemă. Capul burghiului dinamic, în formă de dalta, penetrează rapid în material și simultan creează fluxuri de praf în spirala multi-canal. Spirala special concepută îndepărtează rapid rezidurile, economisind timp și bani.

Acest spirală specială, de asemenea, reduce vibrațiile și transferul de impact energetic de la ciocan la capul de foraj este mai puternic, astfel crescând remarcabil viteza de gaurire și durata de viață a burghiului. Gaurirea este mai puțin solicitantă pentru operator dar și pentru mașina de gaurit.

SDS-MAX TCT BURGHIE ROTOPERCUTIE 2-MUCHII 12-15 MM

 		Ø (mm)	Lungime totala (mm)	Lungime utila (mm)	PQ	MOQ	Cod comanda	Cod de bare
  	12	340	200	1	1	750910	8717154652246	
	12	540	400	1	1	750911	8717154652253	
	12	740	600	1	1	750912	8717154652260	
	12	940	800	1	1	750913	8717154652277	
	14	340	200	1	1	750914	8717154652284	
	14	540	400	1	1	750915	8717154652291	
	14	940	800	1	1	750916	8717154652307	
	15	340	200	1	1	750917	8717154652314	
	15	540	400	1	1	750918	8717154652321	

# PROLINE

## BURGHIE ROTOPERCUTIE

### SDS-MAX SEMI PROFESIONAL Ø 14 – 40 MM

CAPUL BURGHIULUI  
ARE FORMA DE  
DALTA

VARF ROBUST  
DIN CARBURA  
FORMEAZA UN  
UNGHII DE 130°

SPIRALA DE  
TRANSPORT ESTE  
LARGA



REZISTENTA MARE  
LA INDOIRE









Gama de burghie SDS-Max Semi Profesionala este conceputa pentru gaurire in beton, zidarie si piatra naturala. Gama este economica dar sunt burghie rapide, progresul

in material este mare datorita varfului acoperit din carbura metalica.

Spirala larga asigura transportul eficient al rezidurilor. Sunt burghie apreciate pentru

calitatea rezonabila de catre utilizatorii ocazionali, pentru care pretul este prioritar in fata altor indicatori cum ar fi rapiditatea gauririi sau durata de viata.

SDS-MAX SEMI PROFESIONAL BURGHIE ROTOPERCUTIE 14 - 40 MM

 		Ø (mm)	Lungime totala (mm)	Lungime utila (mm)	PQ	MOQ	Cod comanda	Cod de bare
  		14	340	200	1	1	754371	8717574035117
		14	540	400	1	1	754372	8717574035124
		16	340	200	1	1	754373	8717574035131
		16	540	400	1	1	754374	8717574035148
		18	340	200	1	1	754375	8717574035155
		18	540	400	1	1	754376	8717574035162
		20	320	200	1	1	754377	8717574035179
		20	520	400	1	1	754378	8717574035186
		22	320	200	1	1	754379	8717574035193
		22	520	400	1	1	754380	8717574035209
		24	320	200	1	1	754381	8717574035216
		24	520	400	1	1	754382	8717574035223
		25	320	200	1	1	754383	8717574035230
		25	520	400	1	1	754384	8717574035247
		28	370	250	1	1	754385	8717574035254
		28	570	450	1	1	754386	8717574035261
		30	370	250	1	1	754387	8717574035278
		30	570	450	1	1	754388	8717574035285
		32	370	250	1	1	754389	8717574035292
		32	570	450	1	1	754390	8717574035308
	32	920	800	1	1	754391	8717574035315	
	35	370	250	1	1	754392	8717574035322	
	35	570	450	1	1	754393	8717574035339	
	38	370	250	1	1	754394	8717574035346	
	38	570	450	1	1	754395	8717574035353	
	40	370	250	1	1	754396	8717574035360	
	40	570	450	1	1	754397	8717574035377	

# PROLINE

## BURGHIE ROTOPERCUTIE

### SDS-PLUS / SDS-MAX EXTRACTOR DE PRAF

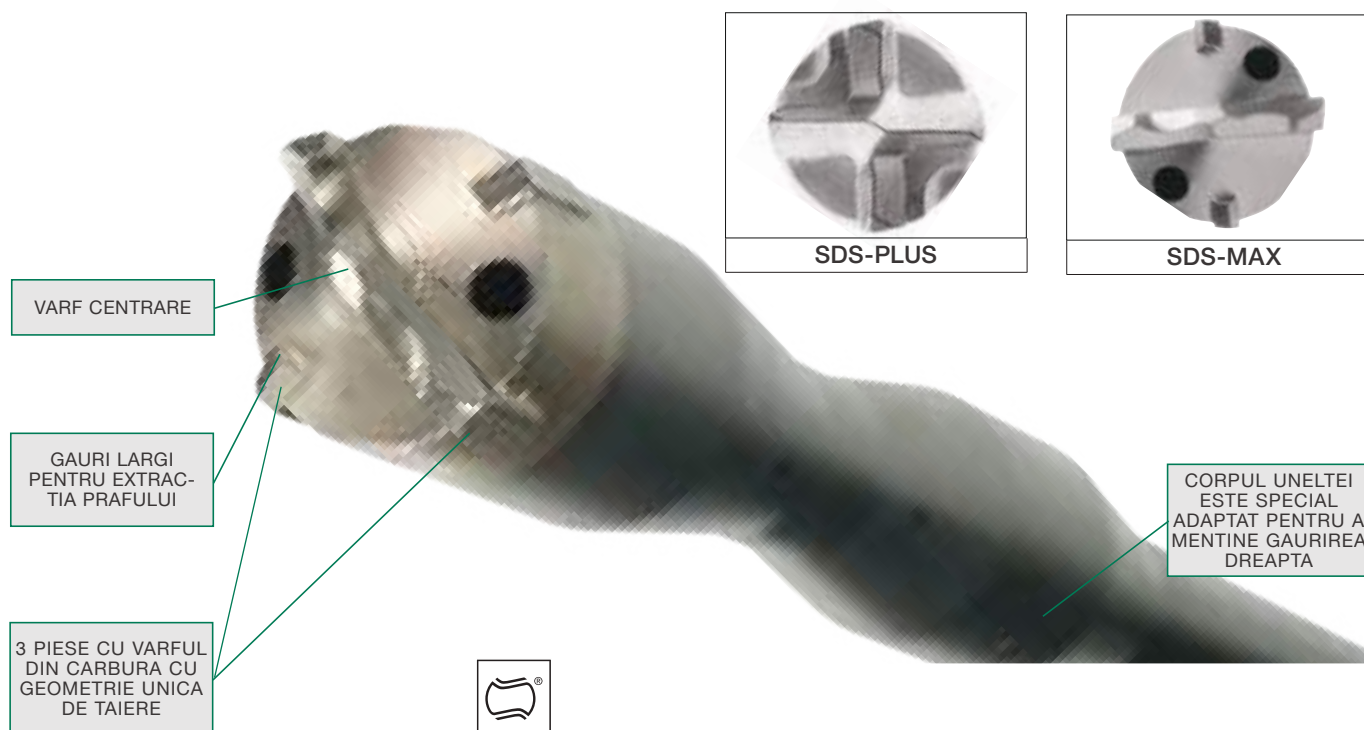

Cu burghiile extractoare praf de la Hikoki aveti solutia perfecta pentru multele probleme dificile din practica. Burghiile de gaurit speciale Dust Free sunt disponibile cu conexiuni SDS-Plus si SDS-Max.

Pe adaptorul standard din plastic cu diametrul interior  $\varnothing$  35 mm, puteti conecta orice tip de adaptor aspirator pentru a folosi aspiratoare industriale (filtru minim recomandat M). Datorita nivelului extrem de ridicat de aspirare a prafului din capul burghiului - aproximativ 98% din praf este extras - utilizatorul va experimenta in primul rand viteza extrem de mare de gaurire dar si vibratiile reduse în comparatie cu un burghiu standard.

Extragerea prafului cu ajutorul aspiratoarelor profesionale reduce de asemenea inhalarea prafului de catre operator deoa-

rece toate particulele de praf daunatoare sunt extrase la sursa. Acest lucru este un mare beneficiu pentru utilizator. De asemenea, in medii de lucru unde praful este considerat ca fiind foarte neplacut, cum ar fi spitalele, mediul de viata sau orice alt loc unde oamenii continua sa traiasca sau sa lucreze in timpul procesului de foraj, aceste burghie ofera o solutie excelenta.

Atunci cand gaura este gata, lucrarea este terminata imediat si dupa aceea nu mai este necesara curatarea locului. Burghiul de gaurit fara praf confera o solutie excelenta pentru operator atunci cand se gaureste vertical, orizontal sau chiar si forajul plafonului.



Cand gaura este pregatita pentru dibluri, in gaura nu este lasat niciun surplus de reziduri, ceea ce usureaza fixarea ace-

stora. Burghiile extractoare de praf ofera o solutie eficienta din punctul de vedere al costurilor pentru utilizatorul final datorita economiilor rezultate din faptul ca nu este necesara angajarea suplimentara a oamenilor de curatenie.





Toate burghiile de gaurit fara praf sunt echipate cu un design inovator cu 4 muchii, asigurând o concentricitate precisa si o precizie Dimensiuneala mare a gaurilor executate, in conformitate cu normele PGM.

Datorita extractiei prafului, in jurul capului de gaurire exista un flux continuu de aer care creeaza o racire activ a capului burghiului, fapt care mareste durata de viata.

**BURGHIU SDS-PLUS PENTRU EXTRACTIA PRAFULUI**

 	Ø (mm)	Lungime totala (mm)	Lungime utila (mm)	PQ	MOQ	Cod comanda	Cod de bare
	12	325	200	1	1	783401	8717574057607
	14	360	240	1	1	783402	8717574057614
	16	360	240	1	1	783403	8717574057621
	18	360	240	1	1	783404	8717574057638

**BURGHIU SDS-PLUS PENTRU EXTRACTIA PRAFULUI**

 	Ø (mm)	Lungime totala (mm)	Lungime utila (mm)	PQ	MOQ	Cod comanda	Cod de bare
 	16	600	400	1	1	783411	8717574057645
	18	600	400	1	1	783412	8717574057652
	20	600	400	1	1	783413	8717574057669
	22	600	400	1	1	783414	8717574057676
	24	600	400	1	1	783415	8717574057683
	25	600	400	1	1	783416	8717574057690
	28	600	400	1	1	783417	8717574057706
	28	900	700	1	1	783418	8717574057713
	30	600	400	1	1	783419	8717574057720
	30	900	700	1	1	783420	8717574057737
	32	600	400	1	1	783421	8717574057744
	32	900	700	1	1	783422	8717574057751
	35	600	400	1	1	783423	8717574057768
	35	900	700	1	1	783424	8717574057775

**CONECTOR PENTRU FURTUNUL DE ASPIRATOR**

	Descriere	PQ	MOQ	Cod comanda	Cod de bare
	Conector pt. gaurire cu SDS-Plus	1	1	783428	8717574058208
	Conector pt. gaurire cu SDS-Max	1	1	783429	8717574058215

**BURGHIE ROTOPERCUTIE**

# PROLINE

## BURGHIE DE STRAPUNGERE



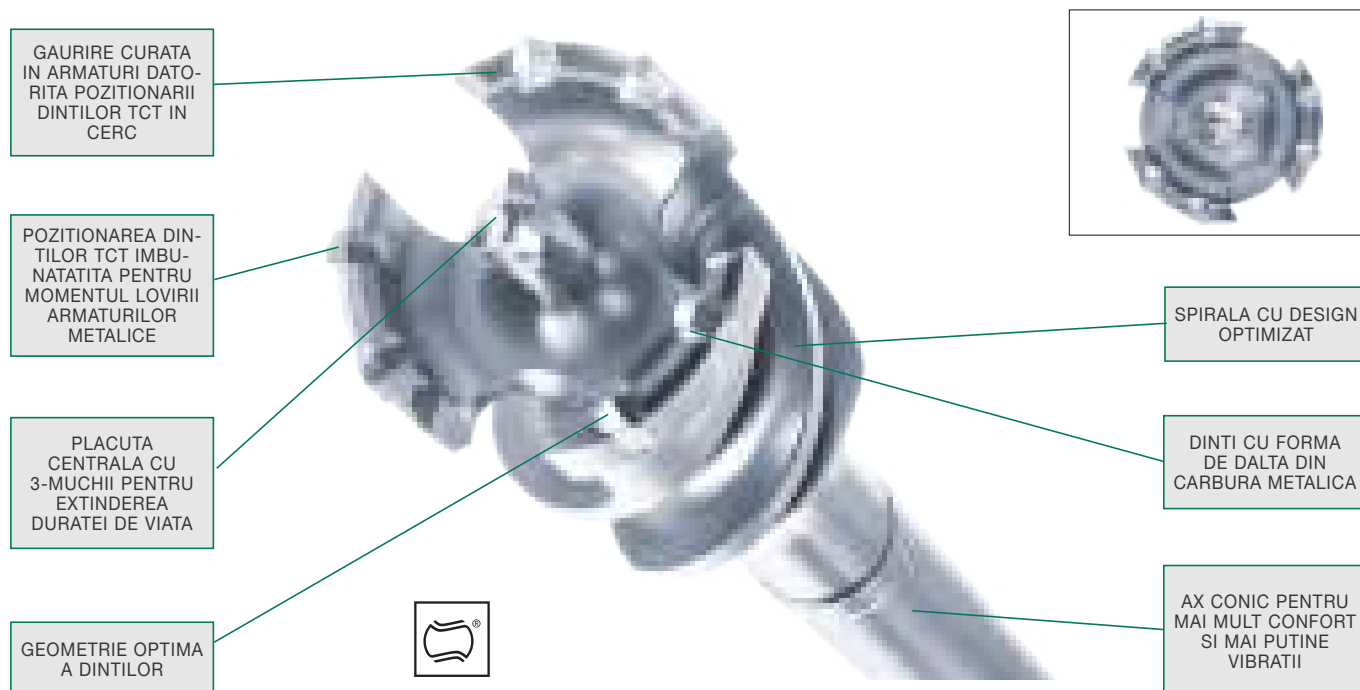



### SDS-MAX TCT



Burghiile de strapungere Hikoki garanteaza o manipulare eficienta datorita designului aplicat dintr-o singura bucată. Designul se concentreaza pe noua generatie de burghie destinate utilizarii pe ciocane rotopercutoare puternice si ofera eficienta ridicata cu durabilitate mare. Sunt ideale pentru gaurire



în beton, piatra naturala si zidarie. Cele 3 spirale supradimensionate asigura evacuarea rapida a rezidurilor, progresul rapid si vibratii reduse in timpul forajului. Rezultatul consta in gauri precise, rotunde si la nivel profesional. Rezistenta la rupere este mare si vibratiile in

timpul forajului sunt scazute datorita latimii spirelor si a grosimii bazei. Multumita zonei scurte a spiralei rezulta o greutate redusa a burghiului fapt care asigura usurinta in lucru.





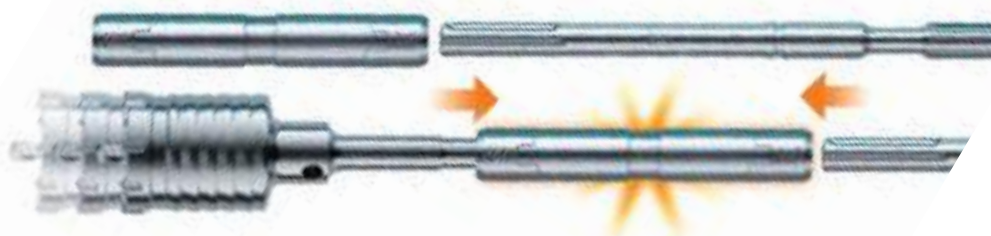

BURGHIE DE STRAPUNGERE SDS-MAX TCT								
		Ø (mm)	Lungime totala (mm)	Lungime utila (mm)	PQ	MOQ	Cod comanda	Cod de bare
		40	550	410	1	1	751691	8717574055153
		45	550	410	1	1	751692	8717574055160
		45	990	850	1	1	751693	8717574055177
		55	550	410	1	1	751694	8717574055184
		55	990	850	1	1	751695	8717574055191
		65	550	410	1	1	751696	8717574055207
		65	990	850	1	1	751697	8717574055214
		80	550	410	1	1	751698	8717574055221
		80	990	850	1	1	751699	8717574055238
BURGHIE DE STRAPUNGERE SDS-MAX TCT (LUNGIMI SPECIALE IN DESIGN CONVENTIONAL)								
		40	310	170	1	1	751651	8717154657715
		40	550	410	1	1	751652	8717154657722
		55	310	170	1	1	751656	8717154657760

# PROLINE

## ACCESORII SDS-MAX

ACCESORII SDS-MAX					
	Descriere	PQ	MOQ	Cod comanda	Cod de bare
<b>PRELUNGITOR PENTRU BURGHE DE GAURIT &gt; 32 MM</b>					
	Lungime totala 320 mm	1	1	751675	8717472817990
	Lungime totala 750 mm	1	1	751676	8717472818003
	Lungime totala 1100 mm	1	1	751677	8717472818010
	Adaptor pentru prelungitor	1	1	751686	8717472818102





ADAPTOARE SDS-MAX					
	Descriere	PQ	MOQ	Cod comanda	Cod de bare
<b>ADAPTOARE DE LA SDS-MAX</b>					
	SDS-Max la 1/2" x 20 UNF filet exterior	1	1	750453	8717472818744
	SDS-Max la 1/2" patrat	1	1	750451	8717574023848
	SDS-Max la 3/4" patrat	1	1	750452	8717574023855
	SDS-Max adaptor la conexiune SDS-Plus	1	1	751006	8717154652772
	SDS-Max adaptor la conexiune Spline	1	1	751049	8717574025897
<b>ADAPTOR LA SDS-MAX</b>					
	Adaptor din Spline la conexiune SDS-Max	1	1	750247	8717574025880

ADAPTOR 13 MM HEXAGONAL					
	Descriere	PQ	MOQ	Cod comanda	Cod de bare
	Adaptor de la 13 mm hexagon la SDS-Plus	1	1	750246	8717154651997

# PROLINE

## BURGHIE ROTOPERCUTIE

### CAROTE

CAROTE ROTOPERCUTIE							
1:8	Descriere	Ø (mm)	Lungime totala (mm)	PQ	MOQ	Cod comanda	Cod de bare
<b>CAROTE CU PRINDERE PE CON 1 : 8</b>							
 	Carota	40	100	1	1	750960	8717472816252
	Carota	45	100	1	1	751055	8717574023534
	Carota	50	100	1	1	750961	8717472816269
	Carota	60	100	1	1	751058	8717574023541
	Carota	65	100	1	1	750962	8717472816276
	Carota	68	100	1	1	751056	8717574023558
	Carota	80	100	1	1	750963	8717472816283
	Carota	90	100	1	1	750964	8717472816290
	Carota	100	100	1	1	750965	8717472816306
	Carota	125	100	1	1	750966	8717472816313
	Burghiu central	11	120	1	1	750967	8717472816320
	Pin ejector			1	1	750974	8717472816399
	Prind SDS-Plus		115	1	1	751029	8717472816405
	Prind SDS-Max		180	1	1	750968	8717472816337
	Prind SDS-Max		450	1	1	750969	8717472816344
	Prind Spline		216	1	1	750970	8717472816351
	Prind Spline		436	1	1	750971	8717472816368
Prind Hex 13		450	1	1	750973	8717472816382	



# PROLINE

## BURGHIE ROTOPERCUTIE

### GAURIRE CU VARIA SYSTEM

GAURIRE CU VARIA SYSTEM							
VARIA	Descriere	Ø (mm)	Lungime utila (mm)	PQ	MOQ	Cod comanda	Cod de bare
	Burghiu	28	475	1	1	751051	8717574035070
	Burghiu	30	475	1	1	751052	8717574035087
	Burghiu	32	475	1	1	751053	8717574035094
GAURIRE CU CAROTE ROTOPERCUTIE CU FILET INTERIOR CU VARIA SYSTEM							
	Carota	50	100	1	1	760086	8717472816511
	Carota	68	100	1	1	760087	8717472816528
	Carota	80	100	1	1	760088	8717472816535
	Carota	90	100	1	1	760071	8717472816542
	Carota	100	100	1	1	760072	8717472816559
	Carota	125	100	1	1	760073	8717472816566
BURGHIU CENTRARE CAROTE VARIA SYSTEM							
	Center drill bit	12	155	1	1	760074	8717472816573
GAURIRE CU VARIA SYSTEM							
	Freza strapungere	35	150	1	1	744120	8717574014266
	Freza strapungere	40	150	1	1	744121	8717472816429
	Freza strapungere	45	150	1	1	744122	8717472816436
	Freza strapungere	50	150	1	1	744119	8717574014273
	Freza strapungere	55	150	1	1	744123	8717472816443
	Freza strapungere	68	150	1	1	744124	8717472816450
	Freza strapungere	80	150	1	1	744125	8717472816467
ADAPTOR VARIA SYSTEM CU FILET							
	Pentru SDS-Max		195	1	1	760085	8717472816498
	Pt. 13 mm hexagonal		180	1	1	744126	8717574002072
	Pt. 19 mm hexagonal		180	1	1	744127	8717574011791
	Pentru Spline		180	1	1	744128	8717472816504
VARIA SYSTEM EXTENSIE CU FILET							
	Extensie	25	280	1	1	744129	8717472816474
VARIA SYSTEM PRINDERE CU FILET							
	Prindere cu filet			1	1	744130	8717472816481

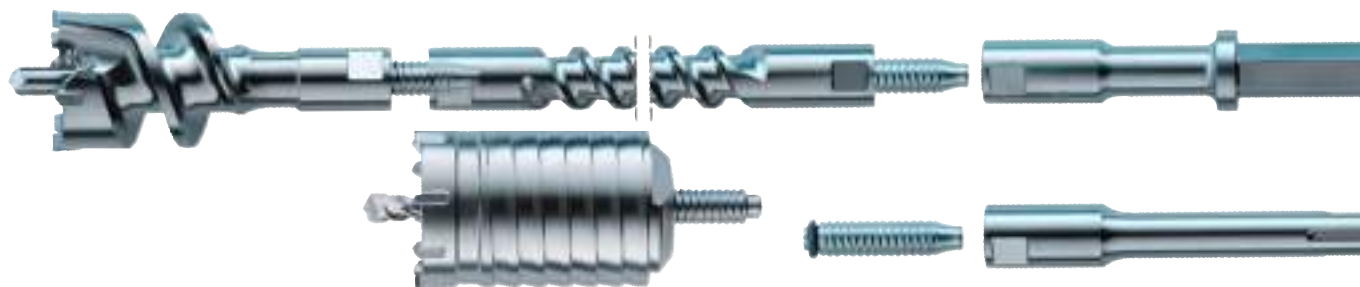



# PROLINE

## BURGHIE PENTRU ZIDARIE



CAPUL IN FORMA DE DALTA DIN CARBURA

SPIRALA-S CU GEOMETRIE ROBUSTA





SPIRALE LARGI CU VOLUM MARE DE TRANSPORT

Burghiile Hikoki cu prindere cilindrica sunt concepute pentru performanta optima, sunt echipate cu un varf special si au o geometrie



a spiralei perfect adaptata pentru performante ridicate la forajul in beton si zidarie.

Unelte in conformitate cu standardele DIN 8039 ISO 5468.



### BURGHIE PENTRU BETON / ZIDARIE CU PRINDERE CILINDRICA

	Ø (mm)	Lungime totala (mm)	Lungime utila (mm)	PQ	MOQ	Cod comanda	Cod de bare
  	3	70	40	1	1	780851	8717574021707
	4	85	50	1	1	780852	8717574021714
	5	85	50	1	1	780853	8717574021721
	5	150	115	1	1	780854	8717574021738
	5,5	85	50	1	1	780855	8717574021745
	5,5	150	115	1	1	780856	8717574021752
	6	100	60	1	1	780857	8717574021769
	6	150	110	1	1	780858	8717574021776
	6	200	160	1	1	780859	8717574021783
	6	400	360	1	1	780860	8717574021790
	6	600	560	1	1	780861	8717574021806
	6,5	100	60	1	1	780862	8717574021813
	6,5	150	110	1	1	780863	8717574021820
	7	100	60	1	1	780864	8717574021837
	7	150	110	1	1	780865	8717574021844
	8	120	80	1	1	780866	8717574021851
	8	200	160	1	1	780867	8717574021868
	8	400	360	1	1	780868	8717574021875
	8	600	560	1	1	780869	8717574021882
	9	120	80	1	1	780870	8717574021899
10	120	80	1	1	780871	8717574021905	
10	200	160	1	1	780872	8717574021912	
10	400	360	1	1	780873	8717574021929	
10	600	560	1	1	780874	8717574021936	





**BURGHIE PENTRU BETON / ZIDARIE CU PRINDERE CILINDRICA, 10 MM**

	Ø (mm)	Lungime totala (mm)	Lungime utila (mm)	PQ	MOQ	Cod comanda	Cod de bare
 	12	150	110	1	1	780875	8717574021943
	12	200	160	1	1	780876	8717574021950
	12	400	360	1	1	780877	8717574021967
	12	600	560	1	1	780878	8717574021974
	13	150	110	1	1	780879	8717574021981
	14	150	110	1	1	780880	8717574021998
	14	200	160	1	1	780881	8717574022001
	14	400	360	1	1	780882	8717574022018
	14	600	560	1	1	780883	8717574022025
	15	160	120	1	1	780884	8717574022032
	16	160	120	1	1	780885	8717574022049
	16	400	360	1	1	780886	8717574022056
	16	600	560	1	1	780887	8717574022063
	18	160	120	1	1	780888	8717574022070
	18	400	360	1	1	780889	8717574022087

**BURGHIE PENTRU BETON / ZIDARIE CU PRINDERE CILINDRICA 13 MM**

	Ø (mm)	Lungime totala (mm)	Lungime utila (mm)	PQ	MOQ	Cod comanda	Cod de bare
 	20	160	120	1	1	780891	8717574022094
	20	400	360	1	1	780892	8717574022100
	20	600	560	1	1	780893	8717574022117
	22	400	360	1	1	780894	8717574022124

**TRUSE BURGHIE PENTRU BETON / ZIDARIE CU PRINDERE CILINDRICA**

	Descriere	PQ	MOQ	Cod comanda	Cod de bare
	5-Buc 4 x 85 mm 5 x 85 mm 6 x 100 mm 8 x 120 mm 10 x 120 mm	5	1	780890	8717574021226
	5-Buc 4 x 85 mm 5 x 85 mm 6 x 100 mm 8 x 120 mm 10 x 120 mm	5	1	780898	8717574022131
	8-Buc 3 x 70 mm 4 x 85 mm 5 x 85 mm 6 x 100 mm 7 x 100 mm 8 x 120 mm 9 x 120 mm 10 x 120 mm	8	1	780899	8717574022148

# PROLINE BURGHIE UNIVERSALE

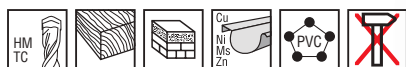

UNGHIU DE TAIERE  
OPTIMIZAT PENTRU  
GAURIRE

VARF DIN CARBURA  
CU BAZA  
DIAMANTATA

SPIRALA LARGA  
PENTRU VOLUM  
MARE DE  
TRANSPORT



## Versatilitate ridicata

Burghiile universale Hikoki sunt concepute pentru a fora într-o gama mare de materiale. De la caramida solida, caramida cu goluri si zidarie, la plastic, lemn si metale moi; acest tip de burghiu intruneste toate aceste capabilitati.

Varful special din carbura patrunde eficient in material. Datorita formei ascutite, baza diamantata a varfului avanseaza rapid in material chiar daca percutia lipseste. Pentru a proteja taisul muchiilor, este conceputa pentru a fi utilizata doar pentru modul gaurire, fara percutie. Dupa taiere, spirala larga

confera un volum mare si rapid de transport al rezidurilor pentru a asigura o progresie continua.

Utilizarea de materiale de inalta calitate folosite la producerea acestor burghie, în combinatie cu calirea si a tehnicilor de lipire a materialelor face ca aceste unelte sa fie unele robuste si profesionale.



## Caracteristici

- Varful din carbura metalica este proiectat cu un unghi de taiere pozitiv agresiv. În combinatie cu marginea ascutita a bazei varfului care este diamantata face ca acest burghiu sa fie perfect pentru a gaurii diverse materiale.
- Volumul mare al spiralei este propice pentru indepartarea rapida a prafului rezultat de gaurire.
- Capul de foraj în forma de dalta penetreaza rapid materialul si, prin urmare, fluxul de praf transportat de spirala este mare.



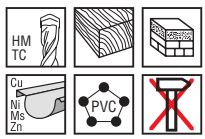

Doar pentru utilizare in modul  
gaurire, fara percutie

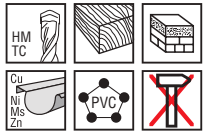

**BURGHIE UNIVERSALE CU PRINDERE CILINDRICA**

	Ø (mm)	Lungime totala (mm)	Lungime utila (mm)	PQ	MOQ	Cod comanda	Cod de bare
 	3	70	40	1	1	780801	8717574042054
	4	85	50	1	1	780802	8717574042061
	5	85	50	1	1	780803	8717574042078
	5,5	85	50	1	1	780804	8717574042085
	6	100	60	1	1	780805	8717574042092
	6	150	110	1	1	780806	8717574042108
	6,5	100	60	1	1	780807	8717574042115
	6,5	150	110	1	1	780808	8717574042122
	7	100	60	1	1	780809	8717574042139
	8	120	80	1	1	780810	8717574042146
	8	250	200	1	1	780811	8717574042153
	9	120	80	1	1	780812	8717574042160
	10	120	80	1	1	780813	8717574042177
	10	250	200	1	1	780814	8717574042184
	12	150	110	1	1	780815	8717574042191
	12	250	200	1	1	780816	8717574042207
	14	250	200	1	1	780817	8717574042214

**BURGHIE UNIVERSALE CU PRINDERE 1/4" HEXAGONALA**

	Ø (mm)	Lungime totala (mm)	Lungime utila (mm)	PQ	MOQ	Cod comanda	Cod de bare
 	3	95	40	1	1	780821	8717574042221
	4	105	50	1	1	780822	8717574042238
	5	105	50	1	1	780823	8717574042245
	5,5	105	50	1	1	780824	8717574042252
	6	115	60	1	1	780825	8717574042269
	6,5	115	60	1	1	780826	8717574042276
	7	115	60	1	1	780827	8717574042283
	8	125	80	1	1	780828	8717574042290

**TRUSE CU BURGHIE UNIVERSALE**

	Descriere	PQ	MOQ	Cod comanda	Cod de bare
	5-Buc 3 x 70 mm 4 x 85 mm 5 x 85 mm 6 x 100 mm 8 x 120 mm	5	1	780818	8717574042801
 	5-Buc 3 x 95 mm 4 x 105 mm 5 x 105 mm 6 x 115 mm 8 x 125 mm	5	1	780829	8717574042818

# PROLINE BURGHIE PENTRU METAL



## Gaurirea Metalului

Burghiile Hikoki pentru gaurit metal ofera înalta calitate si o fiabilitate ridicata pentru orice utilizator profesionist. Pentru a realiza acest lucru, numai cele mai bune materii prime sunt utilizate in procesul de productie sever controlat si certificat. De asemenea, geometria burghiului este optimizata pentru a obtine rezultate mai bune în capacitatea de finisare a gaurii, in viteza de forare si in durata mai lunga de viata.

În timpul procesului de productie a burghiilor de gaurit metal Hikoki, cele mai înalte standarde de calitate sunt îndeplinite. Mediul de productie este în conformitate cu ISO 9001: 2000. Facilitatile de productie, de asemenea, îndeplinesc standardele ridicate impuse de politica Companiei Hikoki, atunci când vine vorba de responsabilitate. Procesul de productie este, de asemenea, in conformitate cu standardele de mediu ISO 14000. Burghiile pentru gaurit metal Hikoki sunt testate în mod regulat în cele mai severe conditii pentru a asigura calitatea si functionalitatea. Aceste masuratori asigura ca burghiile Hikoki pentru gaurit metal sunt printre cele mai eficiente de pe piata, chiar si în cele mai dificile conditii.

## HSS-R

Burghie pentru metal pentru uz general si ocazional cu masina de gaurit de mana (portabila).

### Proprietati

Acest burghiu performant, turnat din otel inoxidabil de înalta calitate, confera o rezistenta sporita la rupere datorita procesului de laminare care întareste materialul.

### Aplicatii

Pentru otel, fonta, materiale aliate si nealiate (pana la rezistenta de 900 N/mm<sup>2</sup>), temperate, nodulare si turnate, fier sinterizat, nichel, grafit, aliaje din aluminiu, cupru si bronz.

## HSS-G

Burghie pentru metal pentru utilizare cu masinile de gaurit de mana (portabile) dar la fel de bine pot fi utilizare pentru gaurirea pe standuri profesionale.

### Proprietati

Aceste burghie au o calitate exceptionala, aceasta fiind viteza de lucru ridicata in otel, fapt care conduce la sporirea acuratetii gauririi.

### Aplicatii

Potrivite pentru oteluri aliate si nealiate pâna la o rezistenta de 900 N / mm<sup>2</sup>, otel turnat, fonta, fier sinterizat, fonta maleabila, metale neferoase si materiale plastice dure.

## HSS-G Co 5

Concepute special pentru gaurire in materiale dure asa cum este otelul inoxidabil.

Burghiile HSS -Co contin 5 % Cobalt. Burghiile HSS -Co sunt potrivite pentru gaurirea materialelor dure si confera o durata lunga de viata.

### Proprietati

Idem HSS-G plus aliaj de cobalt. Cobaltul rezista la temperaturi ridicate generate de rezistenta anumitor metale.

### Aplicatii



Potrivite pentru oteluri aliate si nealiate pâna la o rezistenta de 1000N/mm<sup>2</sup>, inox V2A/V4A, fonta, otel turnat, oteluri intarite cu acid sau calite.



	HSS-R DIN 338	HSS-G DIN 338	HSS-Co DIN 338
<b>DIN</b>	338	338	338
<b>Unghiul varfului</b>	118°	135°	135°
<b>Forma varfului</b>	Dalta	Split DIN1412	Split DIN1412
<b>Unghiul spiralei</b>	22° - 28°	30°	30°
<b>Suprafata</b>	Negru, tratata cu abur	Metal	Auriu
<b>Gama Ø : 1,0 - 13,0 mm</b>	Din 0,5 mm in 0,5 mm	Din 0,1 in 0,1 mm, incl. 0,25 mm	Din 0,1 in 0,1 mm, incl. 0,25 mm
<b>Gama Ø : 13,5 - 20,0 mm</b>	Din 0,5 mm in 0,5 mm	Din 0,5 mm in 0,5 mm	n.a.
<b>Dimensiune prindere</b>	≤ 10 mm identic cu diametrul	≤ 13 mm identic cu diametrul	≤ 13 mm identic cu diametrul
	10 - 13 mm redus 10 mm	10 - 13 mm redus 10 mm	
	≥ 13,5 mm redus 13 mm	≥ 13,5 mm redus 13 mm	
		1/4" hexagonal	
<b>Tipul masinii</b>	De mana ( portabila)	De mana ( portabila)	Stand de gaurire

# PROLINE



## BURGHIE PENTRU GAURIT METAL

### HSS-R DIN 338

BURGHIE PENTRU GAURIT METAL HSS-R DIN 338							
	Ø (mm)	Lungime totala (mm)	Lungime utila (mm)	PQ	MOQ	Cod comanda	Cod de bare
  	1,0	34	12	2	10	780001	8717574003772
	1,5	40	18	2	10	780002	8717574003789
	2,0	49	24	2	10	780003	8717574003796
	2,5	57	30	2	10	780004	8717574003802
	3,0	61	33	2	10	780005	8717574003819
	3,2	65	36	1	10	780006	8717574003826
	3,5	70	39	1	10	780007	8717574003833
	4,0	75	43	1	10	780008	8717574003840
	4,2	75	43	1	10	780009	8717574003857
	4,5	80	47	1	10	780010	8717574003864
	5,0	86	52	1	10	780011	8717574003871
	5,5	93	57	1	10	780012	8717574003888
	6,0	93	57	1	10	780013	8717574003895
	6,5	101	63	1	10	780014	8717574003901
	7,0	109	69	1	10	780015	8717574003918
	7,5	109	69	1	10	780016	8717574003925
	8,0	117	75	1	10	780017	8717574003932
	8,5	117	75	1	5	780018	8717574003949
	9,0	125	81	1	5	780019	8717574003956
	9,5	125	81	1	5	780020	8717574003963
	10,0	133	87	1	5	780021	8717574003970
	10,5	133	87	1	5	780022	8717574003987
	11,0	142	94	1	5	780023	8717574003994
	11,5	142	94	1	5	780024	8717574004007
	12,0	151	101	1	5	780025	8717574004014
	12,5	151	101	1	5	780026	8717574004021
	13,0	151	101	1	5	780027	8717574004038

BURGHIE PENTRU METAL HSS-R DIN 338 PACHETE DE 10 BUCATI							
10x	Ø (mm)	Lungime totala (mm)	Lungime utila (mm)	PQ	MOQ	Cod comanda	Cod de bare
  	1,0	34	12	10	1	780041	8717574004045
	1,5	40	18	10	1	780042	8717574004052
	2,0	49	24	10	1	780043	8717574004069
	2,5	57	30	10	1	780044	8717574004076
	3,0	61	33	10	1	780045	8717574004083
	3,2	65	36	10	1	780046	8717574004090
	3,5	70	39	10	1	780047	8717574004106
	4,0	75	43	10	1	780048	8717574004113
	4,2	75	43	10	1	780049	8717574004120
	4,5	80	47	10	1	780050	8717574004137
	5,0	86	52	10	1	780051	8717574004144



**BURGHIE METAL HSS-R DIN 338 10 BUCATI**

10x	Ø (mm)	Lungime totala (mm)	Lungime utila (mm)	PQ	MOQ	Cod comanda	Cod de bare
  	6,0	93	57	10	1	780053	8717574004168
	6,5	101	63	10	1	780054	8717574004175
	7,0	109	69	10	1	780055	8717574004182
	7,5	109	69	10	1	780056	8717574004199
	8,0	117	75	10	1	780057	8717574004205
	8,5	117	75	10	1	780058	8717574004212
	9,0	125	81	10	1	780059	8717574004229
	9,5	125	81	10	1	780060	8717574004236
	10,0	133	87	10	1	780061	8717574004243



**BURGHIE METAL HSS-R DIN 338 5 BUCATI**

	Ø (mm)	Lungime totala (mm)	Lungime utila (mm)	PQ	MOQ	Cod comanda	Cod de bare
	10,5	133	87	5	1	780062	8717574004250
	11,0	142	94	5	1	780063	8717574004267
	11,5	142	94	5	1	780064	8717574004274
	12,0	151	101	5	1	780065	8717574004281
	12,5	151	101	5	1	780066	8717574004298
	13,0	151	101	5	1	780067	8717574004304

**BURGHIE METAL HSS-R DIN 338 PRINDERE REDUSA 10 MM**

d = 10 mm	Ø (mm)	Lungime totala (mm)	Lungime utila (mm)	PQ	MOQ	Cod comanda	Cod de bare
  	10,5	133	87	1	1	780071	8717574004311
	11,0	142	94	1	1	780072	8717574004328
	11,5	142	94	1	1	780073	8717574004335
	12,0	151	101	1	1	780074	8717574004342
	12,5	151	101	1	1	780075	8717574004359
	13,0	151	101	1	1	780076	8717574004366

**BURGHIE METAL HSS-R DIN 338 PRINDERE REDUSA 13 MM**

d = 13 mm	Ø (mm)	Lungime totala (mm)	Lungime utila (mm)	PQ	MOQ	Cod comanda	Cod de bare
  	13,5	160	108	1	1	780077	8717574004373
	14,0	160	108	1	1	780078	8717574004380
	14,5	169	114	1	1	780079	8717574004397
	15,0	169	114	1	1	780080	8717574004403
	15,5	178	120	1	1	780081	8717574004410
	16,0	178	120	1	1	780082	8717574004427
	16,5	184	125	1	1	780083	8717574004434
	17,0	184	125	1	1	780084	8717574004441
	17,5	191	130	1	1	780085	8717574004458
	18,0	191	130	1	1	780086	8717574004465
	18,5	198	135	1	1	780087	8717574004472
	19,0	198	135	1	1	780088	8717574004489
	19,5	205	140	1	1	780089	8717574004496
	20,0	205	140	1	1	780090	8717574004502

**BURGHIE PENTRU GAURIT METAL HSS-R DIN 338 TRUSE**



	Descriere	PQ	MOQ	Cod comanda	Cod de bare
 	6-Buc 2 x 49 mm 3 x 61 mm 4 x 75 mm 5 x 86 mm 6 x 93 mm 8 x 117 mm	6	1	780094	8717574052510
	10-Buc 1 - 10 mm x 1,0 mm	10	1	780095	8717574052527
	19-Buc 1 - 10 mm x 0,5 mm	19	1	780096	8717574004519
	25-Buc 1 - 13 mm x 0,5 mm	25	1	780097	8717574004526
	170-Buc set contine: 1 - 8 mm x 0,5 mm 10 Pcs 8,5 - 10 mm x 0,5 mm 5 Pcs	170	1	780099	8717574004533





# PROLINE

## BURGHIE PENTRU GAURIT METAL

### HSS-G DIN 338

BURGHIE PENTRU GAURIT METAL HSS-G DIN 338							
	Ø (mm)	Lungime totala (mm)	Lungime utila (mm)	PQ	MOQ	Cod comanda	Cod de bare
   	1,0	34	12	2	10	780201	8717574004632
	1,5	40	18	2	10	780202	8717574004649
	2,0	49	24	2	10	780203	8717574004656
	2,2	53	27	2	10	780204	8717574004663
	2,25	53	27	2	10	780205	8717574004670
	2,5	57	30	2	10	780206	8717574004687
	2,6	57	30	2	10	780207	8717574004694
	2,75	61	33	2	10	780208	8717574004700
	2,8	61	33	2	10	780209	8717574004717
	3,0	61	33	2	10	780210	8717574004724
	3,2	65	36	1	10	780211	8717574004731
	3,25	65	36	1	10	780212	8717574004748
	3,3	65	36	1	10	780213	8717574004755
	3,5	70	39	1	10	780214	8717574004762
	3,75	70	39	1	10	780215	8717574004779
	3,8	75	43	1	10	780216	8717574004786
	4,0	75	43	1	10	780217	8717574004793
	4,1	75	43	1	10	780218	8717574004809
	4,2	75	43	1	10	780219	8717574004816
	4,25	75	43	1	10	780220	8717574004823
	4,3	75	43	1	10	780221	8717574004830
	4,5	80	47	1	10	780222	8717574004847
	4,75	80	47	1	10	780223	8717574004854
	4,8	86	52	1	10	780224	8717574004861
	5,0	86	52	1	10	780225	8717574004878
	5,1	86	52	1	10	780226	8717574004885
	5,2	86	52	1	10	780227	8717574004892
	5,25	86	52	1	10	780228	8717574004908
	5,5	93	57	1	10	780229	8717574004915
	5,75	93	57	1	10	780230	8717574004922
	5,8	93	57	1	10	780231	8717574004939
	6,0	93	57	1	10	780232	8717574004946
6,2	101	63	1	10	780233	8717574004953	
6,25	101	63	1	10	780234	8717574004960	
6,5	101	63	1	10	780235	8717574004977	
6,75	109	69	1	10	780236	8717574004984	
6,8	109	69	1	10	780237	8717574004991	
7,0	109	69	1	10	780238	8717574005004	
7,5	109	69	1	10	780239	8717574005011	
7,8	117	75	1	10	780240	8717574005028	
8,0	117	75	1	10	780241	8717574005035	

**BURGHIE PENTRU GAURIT METAL HSS-G DIN 338**

	Ø (mm)	Lungime totala (mm)	Lungime utila (mm)	PQ	MOQ	Cod comanda	Cod de bare
 	8,5	117	75	1	5	780242	8717574005042
	9,0	125	81	1	5	780243	8717574005059
	9,5	125	81	1	5	780244	8717574005066
	10,0	133	87	1	5	780245	8717574005073
	10,2	133	87	1	5	780246	8717574005080
	10,5	133	87	1	5	780247	8717574005097
	11,0	142	94	1	5	780248	8717574005103
	11,5	142	94	1	5	780249	8717574005110
	12,0	151	101	1	5	780250	8717574005127
	12,5	151	101	1	5	780251	8717574005134
	13,0	151	101	1	5	780252	8717574005141

**BURGHIE PENTRU GAURIT METAL HSS-G DIN 338 10 BUCATI**



10x	Ø (mm)	Lungime totala (mm)	Lungime utila (mm)	PQ	MOQ	Cod comanda	Cod de bare
 	1,0	34	12	10	1	780261	8717574005158
	1,1	36	14	10	1	780262	8717574005165
	1,2	38	16	10	1	780263	8717574005172
	1,25	38	16	10	1	780264	8717574005189
	1,3	38	16	10	1	780265	8717574005196
	1,4	40	18	10	1	780266	8717574005202
	1,5	40	18	10	1	780267	8717574005219
	1,6	43	20	10	1	780268	8717574005226
	1,7	43	20	10	1	780269	8717574005233
	1,75	46	22	10	1	780270	8717574005240
	1,8	46	22	10	1	780271	8717574005257
	1,9	46	22	10	1	780272	8717574005264
	2,0	49	24	10	1	780273	8717574005271
	2,1	49	24	10	1	780274	8717574005288
	2,2	53	27	10	1	780275	8717574005295
	2,25	53	27	10	1	780276	8717574005301
	2,3	53	27	10	1	780277	8717574005318
	2,4	57	30	10	1	780278	8717574005325
	2,5	57	30	10	1	780279	8717574005332
	2,6	57	30	10	1	780280	8717574005349
	2,7	61	33	10	1	780281	8717574005356
	2,75	61	33	10	1	780282	8717574005363
	2,8	61	33	10	1	780283	8717574005370
	2,9	61	33	10	1	780284	8717574005387
	3,0	61	33	10	1	780285	8717574005394
	3,1	65	36	10	1	780286	8717574005400
	3,2	65	36	10	1	780287	8717574005417
	3,25	65	36	10	1	780288	8717574005424
	3,3	65	36	10	1	780289	8717574005431
	3,4	70	39	10	1	780290	8717574005448
3,5	70	39	10	1	780291	8717574005455	
3,6	70	39	10	1	780292	8717574005462	
3,7	70	39	10	1	780293	8717574005479	
3,75	70	39	10	1	780294	8717574005486	
3,8	75	43	10	1	780295	8717574005493	
3,9	75	43	10	1	780296	8717574005509	
4,0	75	43	10	1	780297	8717574005516	
4,1	75	43	10	1	780298	8717574005523	
4,2	75	43	10	1	780299	8717574005530	
4,25	75	43	10	1	780300	8717574005547	

**BURGHIE PENTRU GAURIT METAL**

**BURGHIE PENTRU GAURIT METAL HSS-G DIN 338 10 BUCATI**

10x	Ø (mm)	Lungime totala (mm)	Lungime utila (mm)	PQ	MOQ	Cod comanda	Cod de bare
  	4,3	75	43	10	1	780301	8717574005554
	4,4	80	47	10	1	780302	8717574005561
	4,5	80	47	10	1	780303	8717574005578
	4,6	80	47	10	1	780304	8717574005585
	4,7	80	47	10	1	780305	8717574005592
	4,75	80	47	10	1	780306	8717574005608
	4,8	86	52	10	1	780307	8717574005615
	4,9	86	52	10	1	780308	8717574005622
	5,0	86	52	10	1	780309	8717574005639
	5,1	86	52	10	1	780310	8717574005646
	5,2	86	52	10	1	780311	8717574005653
	5,25	86	52	10	1	780312	8717574005660
	5,3	86	52	10	1	780313	8717574005677
	5,4	93	57	10	1	780314	8717574005684
	5,5	93	57	10	1	780315	8717574005691
	5,6	93	57	10	1	780316	8717574005707
	5,7	93	57	10	1	780317	8717574005714
	5,75	93	57	10	1	780318	8717574005721
	5,8	93	57	10	1	780319	8717574005738
	5,9	93	57	10	1	780320	8717574005745
	6,0	93	57	10	1	780321	8717574005752
	6,1	101	63	10	1	780322	8717574005769
	6,2	101	63	10	1	780323	8717574005776
	6,25	101	63	10	1	780324	8717574005783
	6,3	101	63	10	1	780325	8717574005790
	6,4	101	63	10	1	780326	8717574005806
	6,5	101	63	10	1	780327	8717574005813
	6,6	101	63	10	1	780328	8717574005820
	6,7	101	63	10	1	780329	8717574005837
	6,75	109	69	10	1	780330	8717574005844
	6,8	109	69	10	1	780331	8717574005851
	6,9	109	69	10	1	780332	8717574005868
	7,0	109	69	10	1	780333	8717574005875
	7,1	109	69	10	1	780334	8717574005882
7,2	109	69	10	1	780335	8717574005899	
7,25	109	69	10	1	780336	8717574005905	
7,3	109	69	10	1	780337	8717574005912	
7,4	109	69	10	1	780338	8717574005929	
7,5	109	69	10	1	780339	8717574005936	
7,6	117	75	10	1	780340	8717574005943	
7,7	117	75	10	1	780341	8717574005950	
7,75	117	75	10	1	780342	8717574005967	
7,8	117	75	10	1	780343	8717574005974	
7,9	117	75	10	1	780344	8717574005981	
8,0	117	75	10	1	780345	8717574005998	

**BURGHIE PENTRU GAURIT METAL HSS-G DIN 338 5 BUCATI**



5x	Ø (mm)	Lungime totala (mm)	Lungime utila (mm)	PQ	MOQ	Cod comanda	Cod de bare
 	8,1	117	75	5	1	780346	8717574006001
	8,2	117	75	5	1	780347	8717574006018
	8,25	117	75	5	1	780348	8717574006025
	8,3	117	75	5	1	780349	8717574006032
	8,4	117	75	5	1	780350	8717574006049
	8,5	117	75	5	1	780351	8717574006056

BURGHIE PENTRU GAURIT METAL HSS-G DIN 338 5 BUCATI



5x	Ø (mm)	Lungime totala (mm)	Lungime utila (mm)	PQ	MOQ	Cod comanda	Cod de bare
  	8,6	125	81	5	1	780352	8717574006063
	8,7	125	81	5	1	780353	8717574006070
	8,75	125	81	5	1	780354	8717574006087
	8,8	125	81	5	1	780355	8717574006094
	8,9	125	81	5	1	780356	8717574006100
	9,0	125	81	5	1	780357	8717574006117
	9,1	125	81	5	1	780358	8717574006124
	9,2	125	81	5	1	780359	8717574006131
	9,25	125	81	5	1	780360	8717574006148
	9,3	125	81	5	1	780361	8717574006155
	9,4	125	81	5	1	780362	8717574006162
	9,5	125	81	5	1	780363	8717574006179
	9,6	133	87	5	1	780364	8717574006186
	9,7	133	87	5	1	780365	8717574006193
	9,75	133	87	5	1	780366	8717574006209
	9,8	133	87	5	1	780367	8717574006216
	9,9	133	87	5	1	780368	8717574006223
	10,0	133	87	5	1	780369	8717574006230
	10,1	133	87	5	1	780370	8717574006247
	10,2	133	87	5	1	780371	8717574006254
	10,25	133	87	5	1	780372	8717574006261
	10,3	133	87	5	1	780373	8717574006278
	10,4	133	87	5	1	780374	8717574006285
	10,5	133	87	5	1	780375	8717574006292
	10,6	133	87	5	1	780376	8717574006308
	10,7	142	94	5	1	780377	8717574006315
	10,75	142	94	5	1	780378	8717574006322
	10,8	142	94	5	1	780379	8717574006339
	10,9	142	94	5	1	780380	8717574006346
	11,0	142	94	5	1	780381	8717574006353
	11,1	142	94	5	1	780382	8717574006360
	11,2	142	94	5	1	780383	8717574006377
	11,25	142	94	5	1	780384	8717574006384
	11,3	142	94	5	1	780385	8717574006391
11,4	142	94	5	1	780386	8717574006407	
11,5	142	94	5	1	780387	8717574006414	
11,6	142	94	5	1	780388	8717574006421	
11,7	142	94	5	1	780389	8717574006438	
11,75	142	94	5	1	780390	8717574006445	
11,8	142	94	5	1	780391	8717574006452	
11,9	142	94	5	1	780392	8717574006469	
12,0	151	101	5	1	780393	8717574006476	
12,1	151	101	5	1	780394	8717574006483	
12,2	151	101	5	1	780395	8717574006490	
12,25	151	101	5	1	780396	8717574006506	
12,3	151	101	5	1	780397	8717574006513	
12,4	151	101	5	1	780398	8717574006520	
12,5	151	101	5	1	780399	8717574006537	
12,6	151	101	5	1	780400	8717574006544	
12,7	151	101	5	1	780401	8717574006551	
12,75	151	101	5	1	780402	8717574006568	
12,8	151	101	5	1	780403	8717574006575	
12,9	151	101	5	1	780404	8717574006582	
13,0	151	101	5	1	780405	8717574006599	

BURGHIE PENTRU GAURIT METAL



**BURGHIE PENTRU GAURIT METAL HSS-G DIN 338 PRINDERE REDUSA 10 MM**

	$\emptyset$ (mm)	Lungime totala (mm)	Lungime utila (mm)	PQ	MOQ	Cod comanda	Cod de bare
 	10,5	133	87	1	1	780411	8717574006605
	11,0	142	94	1	1	780412	8717574006612
	11,5	142	94	1	1	780413	8717574006629
	12,0	151	101	1	1	780414	8717574006636
	12,5	151	101	1	1	780415	8717574006643
	13,0	151	101	1	1	780416	8717574006650

**BURGHIE PENTRU GAURIT METAL HSS-G DIN 338 PRINDERE REDUSA 13 MM**

	$\emptyset$ (mm)	Lungime totala (mm)	Lungime utila (mm)	PQ	MOQ	Cod comanda	Cod de bare
 	13,5	160	108	1	1	780420	8717574006667
	14,0	160	108	1	1	780421	8717574006674
	14,5	169	114	1	1	780422	8717574006681
	15,0	169	114	1	1	780423	8717574006698
	15,5	178	120	1	1	780424	8717574006704
	16,0	178	120	1	1	780425	8717574006711
	16,5	184	125	1	1	780426	8717574006728
	17,0	184	125	1	1	780427	8717574006735
	17,5	191	130	1	1	780428	8717574006742
	18,0	191	130	1	1	780429	8717574006759
	18,5	198	135	1	1	780430	8717574006766
	19,0	198	135	1	1	780431	8717574006773
	19,5	205	140	1	1	780432	8717574006780
	20,0	205	140	1	1	780433	8717574006797





**BURGHIE PENTRU GAURIT METAL HSS-G DIN 338 1/4" PRINDERE HEXAGONALA**

	$\emptyset$ (mm)	Lungime totala (mm)	Lungime utila (mm)	PQ	MOQ	Cod comanda	Cod de bare
 	3,0	76	33	1	1	780441	8717574006803
	3,2	80	36	1	1	780442	8717574006810
	4,0	90	43	1	1	780443	8717574006827
	4,2	90	43	1	1	780444	8717574006834
	5,0	101	52	1	1	780445	8717574006841
	6,0	108	57	1	1	780446	8717574006858
	8,0	117	75	1	1	780447	8717574006865
	10,0	133	87	1	1	780448	8717574006872
	12,0	151	101	1	1	780449	8717574006889
	13,0	151	101	1	1	780450	8717574006896

**BURGHIE PENTRU GAURIT METAL HSS-G DIN 338 TRUSE**

★★		Descriere	PQ	MOQ	Cod comanda	Cod de bare
		 <p>6-Buc 2 x 49 mm 3 x 61 mm 4 x 75 mm 5 x 86 mm 6 x 93 mm 8 x 117 mm</p>	6	1	780462	8717574011777
		 <p>19-Buc 1 - 10 mm x 0,5 mm</p>	19	1	780460	8717574006902
		 <p>25-Buc 1 - 13 mm x 0,5 mm</p>	25	1	780461	8717574006919
	 	 <p>5-Buc 3 x 76 mm 4 x 90 mm 5 x 101 mm 6 x 108 mm 8 x 117 mm</p>	5	1	780465	8717574006926





**BURGHIE PENTRU GAURIT METAL HSS-G DIN 338 TRUSE**

★★		Descriere	PQ	MOQ	Cod comanda	Cod de bare
		 <p>19-Buc 1 - 10 mm x 0,5 mm</p>	19	1	780466	8717574052534
		 <p>25-Buc 1 - 13 mm x 0,5 mm</p>	25	1	780467	8717574052541

# PROLINE

## BURGHIE PENTRU GAURIT METAL

### HSS-Co DIN 338

BURGHIE PENTRU GAURIT METAL HSS-Co DIN 338							
	Ø (mm)	Lungime totala (mm)	Lungime utila (mm)	PQ	MOQ	Cod comanda	Cod de bare
    	1,0	34	12	2	10	780501	8717574007077
	1,5	40	18	2	10	780502	8717574007084
	2,0	49	24	2	10	780503	8717574007091
	2,25	53	27	2	10	780504	8717574007107
	2,5	57	30	2	10	780505	8717574007114
	2,75	61	33	2	10	780506	8717574007121
	3,0	61	33	2	10	780507	8717574007138
	3,2	65	36	1	10	780508	8717574007145
	3,25	65	36	1	10	780509	8717574007152
	3,3	65	36	1	10	780510	8717574007169
	3,5	70	39	1	10	780511	8717574007176
	3,75	70	39	1	10	780512	8717574007183
	4,0	75	43	1	10	780513	8717574007190
	4,1	75	43	1	10	780514	8717574007206
	4,2	75	43	1	10	780515	8717574007213
	4,25	75	43	1	10	780516	8717574007220
	4,5	80	47	1	10	780517	8717574007237
	4,75	80	47	1	10	780518	8717574007244
	4,8	86	52	1	10	780519	8717574007251
	5,0	86	52	1	10	780520	8717574007268
	5,1	86	52	1	10	780521	8717574007275
	5,2	86	52	1	10	780522	8717574007282
	5,25	86	52	1	10	780523	8717574007299
	5,5	93	57	1	10	780524	8717574007305
	5,75	93	57	1	10	780525	8717574007312
	6,0	93	57	1	10	780526	8717574007329
	6,25	101	63	1	10	780527	8717574007336
	6,5	101	63	1	10	780528	8717574007343
	6,75	109	69	1	10	780529	8717574007350
	6,8	109	69	1	10	780530	8717574007367
	7,0	109	69	1	10	780531	8717574007374
	7,5	109	69	1	10	780532	8717574007381
	8,0	117	75	1	10	780533	8717574007398
8,5	117	75	1	5	780534	8717574007404	
9,0	125	81	1	5	780535	8717574007411	
9,5	125	81	1	5	780536	8717574007428	
10,0	133	87	1	5	780537	8717574007435	
10,2	133	87	1	5	780538	8717574007442	
10,5	133	87	1	5	780539	8717574007459	
11,0	142	94	1	5	780540	8717574007466	
11,5	142	94	1	5	780541	8717574007473	
12,0	151	101	1	5	780542	8717574007480	
12,5	151	101	1	5	780543	8717574007497	
13,0	151	101	1	5	780544	8717574009965	







BURGHIE PENTRU GAURIT METAL HSS-Co DIN 338 10 BUCATI





10x	Ø (mm)	Lungime totala (mm)	Lungime utila (mm)	PQ	MOQ	Cod comanda	Cod de bare
     	1,0	34	12	10	1	780551	871757407503
	1,1	36	14	10	1	780552	871757407510
	1,2	38	16	10	1	780553	871757407527
	1,25	38	16	10	1	780554	871757407534
	1,3	38	16	10	1	780555	871757407541
	1,4	40	18	10	1	780556	871757407558
	1,5	40	18	10	1	780557	871757407565
	1,6	43	20	10	1	780558	871757407572
	1,7	43	20	10	1	780559	871757407589
	1,75	46	22	10	1	780560	871757407596
	1,8	46	22	10	1	780561	871757407602
	1,9	46	22	10	1	780562	871757407619
	2,0	49	24	10	1	780563	871757407626
	2,1	49	24	10	1	780564	871757407633
	2,2	53	27	10	1	780565	871757407640
	2,25	53	27	10	1	780566	871757407657
	2,3	53	27	10	1	780567	871757407664
	2,4	57	30	10	1	780568	871757407671
	2,5	57	30	10	1	780569	871757407688
	2,6	57	30	10	1	780570	871757407695
	2,7	61	33	10	1	780571	871757407701
	2,75	61	33	10	1	780572	871757407718
	2,8	61	33	10	1	780573	871757407725
	2,9	61	33	10	1	780574	871757407732
	3,0	61	33	10	1	780575	871757407749
	3,1	65	36	10	1	780576	871757407756
	3,2	65	36	10	1	780577	871757407763
	3,25	65	36	10	1	780578	871757407770
	3,3	65	36	10	1	780579	871757407787
	3,4	70	39	10	1	780580	871757407794
	3,5	70	39	10	1	780581	871757407800
	3,6	70	39	10	1	780582	871757407817
	3,7	70	39	10	1	780583	871757407824
3,75	70	39	10	1	780584	871757407831	
3,8	75	43	10	1	780585	871757407848	
3,9	75	43	10	1	780586	871757407855	
4,0	75	43	10	1	780587	871757407862	
4,1	75	43	10	1	780588	871757407879	
4,2	75	43	10	1	780589	871757407886	
4,25	75	43	10	1	780590	871757407893	
4,3	75	43	10	1	780591	871757407909	
4,4	80	47	10	1	780592	871757407916	
4,5	80	47	10	1	780593	871757407923	
4,6	80	47	10	1	780594	871757407930	
4,7	80	47	10	1	780595	871757407947	
4,75	80	47	10	1	780596	871757407954	
4,8	86	52	10	1	780597	871757407961	
4,9	86	52	10	1	780598	871757407978	
5,0	86	52	10	1	780599	871757407985	
5,1	86	52	10	1	780600	871757407992	
5,2	86	52	10	1	780601	871757408005	
5,25	86	52	10	1	780602	871757408012	

BURGHIE PENTRU GAURIT METAL

**BURGHIE PENTRU GAURIT METAL HSS-Co DIN 338 10 BUCATI**

10x	Ø (mm)	Lungime totala (mm)	Lungime utila (mm)	PQ	MOQ	Cod comanda	Cod de bare
    	5,3	86	52	10	1	780603	871757408029
	5,4	93	57	10	1	780604	871757408036
	5,5	93	57	10	1	780605	871757408043
	5,6	93	57	10	1	780606	871757408050
	5,7	93	57	10	1	780607	871757408067
	5,75	93	57	10	1	780608	871757408074
	5,8	93	57	10	1	780609	871757408081
	5,9	93	57	10	1	780610	871757408098
	6,0	93	57	10	1	780611	871757408104
	6,1	101	63	10	1	780612	871757408111
	6,2	101	63	10	1	780613	871757408128
	6,25	101	63	10	1	780614	871757408135
	6,3	101	63	10	1	780615	871757408142
	6,4	101	63	10	1	780616	871757408159
	6,5	101	63	10	1	780617	871757408166
	6,6	101	63	10	1	780618	871757408173
	6,7	101	63	10	1	780619	871757408180
	6,75	109	69	10	1	780620	871757408197
	6,8	109	69	10	1	780621	871757408203
	6,9	109	69	10	1	780622	871757408210
	7,0	109	69	10	1	780623	871757408227
	7,1	109	69	10	1	780624	871757408234
	7,2	109	69	10	1	780625	871757408241
	7,25	109	69	10	1	780626	871757408258
	7,3	109	69	10	1	780627	871757408265
	7,4	109	69	10	1	780628	871757408272
	7,5	109	69	10	1	780629	871757408289
	7,6	117	75	10	1	780630	871757408296
	7,7	117	75	10	1	780631	871757408302
	7,75	117	75	10	1	780632	871757408319
	7,8	117	75	10	1	780633	871757408326
	7,9	117	75	10	1	780634	871757408333
	8,0	117	75	10	1	780635	871757408340

**BURGHIE PENTRU GAURIT METAL HSS-Co DIN 338 5 BUCATI**





5x	Ø (mm)	Lungime totala (mm)	Lungime utila (mm)	PQ	MOQ	Cod comanda	Cod de bare
    	8,1	117	75	5	1	780636	871757408357
	8,2	117	75	5	1	780637	871757408364
	8,25	117	75	5	1	780638	871757408371
	8,3	117	75	5	1	780639	871757408388
	8,4	117	75	5	1	780640	871757408395
	8,5	117	75	5	1	780641	871757408401
	8,6	125	81	5	1	780642	871757408418
	8,7	125	81	5	1	780643	871757408425
	8,75	125	81	5	1	780644	871757408432
	8,8	125	81	5	1	780645	871757408449
	8,9	125	81	5	1	780646	871757408456

BURGHIE PENTRU GAURIT METAL HSS-Co DIN 338 5 BUCATI

5x	Ø (mm)	Lungime totala (mm)	Lungime utila (mm)	PQ	MOQ	Cod comanda	Cod de bare
     	9,0	125	81	5	1	780647	8717574008463
	9,1	125	81	5	1	780648	8717574008470
	9,2	125	81	5	1	780649	8717574008487
	9,25	125	81	5	1	780650	8717574008494
	9,3	125	81	5	1	780651	8717574008500
	9,4	125	81	5	1	780652	8717574008517
	9,5	125	81	5	1	780653	8717574008524
	9,6	133	87	5	1	780654	8717574008531
	9,7	133	87	5	1	780655	8717574008548
	9,75	133	87	5	1	780656	8717574008555
	9,8	133	87	5	1	780657	8717574008562
	9,9	133	87	5	1	780658	8717574008579
	10,0	133	87	5	1	780659	8717574008586
	10,1	133	87	5	1	780660	8717574008593
	10,2	133	87	5	1	780661	8717574008609
	10,25	133	87	5	1	780662	8717574008616
	10,3	133	87	5	1	780663	8717574008623
	10,4	133	87	5	1	780664	8717574008630
	10,5	133	87	5	1	780665	8717574008647
	10,6	133	87	5	1	780666	8717574008654
	10,7	142	94	5	1	780667	8717574008661
	10,75	142	94	5	1	780668	8717574008678
	10,8	142	94	5	1	780669	8717574008685
	10,9	142	94	5	1	780670	8717574008692
	11,0	142	94	5	1	780671	8717574008708
	11,1	142	94	5	1	780672	8717574008715
	11,2	142	94	5	1	780673	8717574008722
	11,25	142	94	5	1	780674	8717574008739
	11,3	142	94	5	1	780675	8717574008746
	11,4	142	94	5	1	780676	8717574008753
	11,5	142	94	5	1	780677	8717574008760
	11,6	142	94	5	1	780678	8717574008777
	11,7	142	94	5	1	780679	8717574008784
	11,75	142	94	5	1	780680	8717574008791
11,8	142	94	5	1	780681	8717574008807	
11,9	142	94	5	1	780682	8717574008814	
12,0	151	101	5	1	780683	8717574008821	
12,1	151	101	5	1	780684	8717574008838	
12,2	151	101	5	1	780685	8717574008845	
12,25	151	101	5	1	780686	8717574008852	
12,3	151	101	5	1	780687	8717574008869	
12,4	151	101	5	1	780688	8717574008876	
12,5	151	101	5	1	780689	8717574008883	
12,6	151	101	5	1	780690	8717574008890	
12,7	151	101	5	1	780691	8717574008906	
12,75	151	101	5	1	780692	8717574008913	
12,8	151	101	5	1	780693	8717574008920	
12,9	151	101	5	1	780694	8717574008937	
13,0	151	101	5	1	780695	8717574008944	

BURGHIE PENTRU GAURIT METAL

BURGHIE PENTRU GAURIT METAL HSS-Co DIN 338 TRUSE

		Descriere	PQ	MOQ	Cod comanda	Cod de bare
    	<p>19-Buc 1 - 10 mm x 0,5 mm</p>	19	1	780698	871757408951	
    	<p>25-Buc 1 - 13 mm x 0,5 mm</p>	25	1	780699	871757408968	

# PROLINE BURGHIE PENTRU TABLA

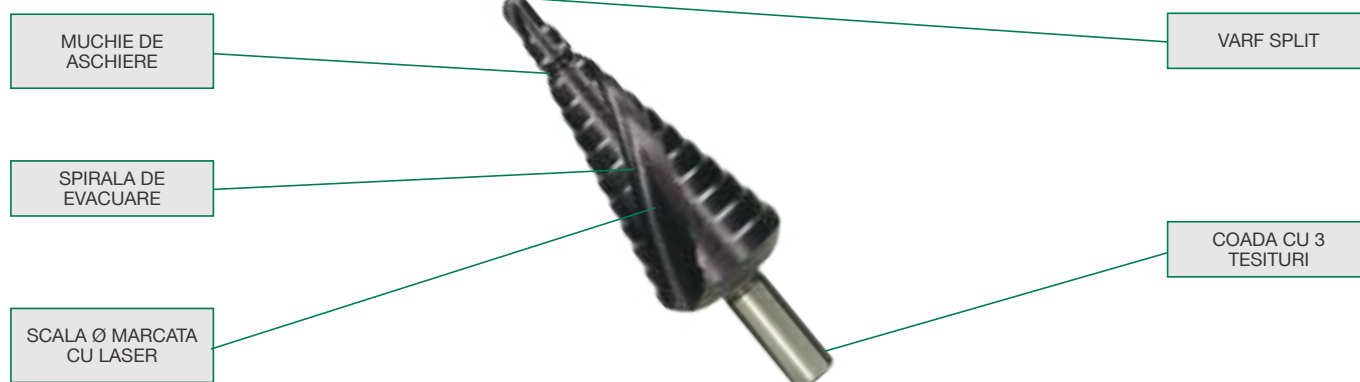

## Burghiu conic in trepte









Burghiile de gaurit tabla Hikoki sunt special concepute pentru efectuarea rapida a gaurilor cu diametrul mare in tabla subtire sau tevi. Se preteaza pentru foraj in diverse materiale cum ar fi plastic, polistiren, otel si otel inoxidabil. Toate diametrele sunt evidentiatare cu laserul pe spirala. Prinderea cu 3 tesituri asigura o transmisie excelenta a cuplului si evita alunecarea in mandrina. Burghiile acoperite cu TiAIN sunt reco-

mandate pentru materiale dificile, cum ar fi otelul inoxidabil, sau pentru gaurirea fara racire. Acoperirea TiAIN reduce temperatura si astfel prelungeste durata de viata a uneltei.





## Caracteristici spirala:

- Nu adera la material
- Aschiere usoara in material
- Zgomot redus in piesa procesata
- Durata mai lunga de functionare
- Taieturi finisate
- Varful care fixeaza locul gaurii elimina alunecarea si necesitatea de perforare prealabila.

	Ø (mm)	Prindere Ø (mm)	Inaltimea pasului (mm)	PQ	MOQ	Cod comanda	Cod de bare
<b>ACOPERIT CU HSS TiAIN, SPIRALA DE EVACUARE</b>							
	4-12	6	5	1	1	780101	8717574055573
	4-20	8	4	1	1	780102	8717574055580
	6-30	10	4	1	1	780103	8717574055597
	4-12	6	5	3	1	780104	8717574055603
	4-20	8	4				
	6-30	10	4				

	Ø (mm)	Prindere Ø (mm)	Inaltimea pasului (mm)	PQ	MOQ	Cod comanda	Cod de bare
<b>ACOPERIRE HSS, SPIRALA DE EVACUARE</b>							
 	4-12	6	5	1	1	780106	8717574055610
	4-20	8	4	1	1	780107	8717574055627
	6-30	10	4	1	1	780108	8717574055634
 	4-12	6	5	3	1	780109	8717574055641
	4-20	8	4				
	6-30	10	4				
<b>ACOPERIRE HSS, CANELURI DREPTE</b>							
 	4-12	6	5	1	1	780111	8717574055818
	4-20	8	4	1	1	780112	8717574055825
	6-30	10	4	1	1	780113	8717574055832
 	4-12	6	5	3	1	780114	8717574055849
	4-20	8	4				
	6-30	10	4				

Burghiile conice Hikoki sunt proiectate si fabricate cu o geometrie de taiere finita 100%: relieful combinat axial / radial, unghiul de taiere profesional la margine poate fi realizat numai prin tehnologia noastra de sleuire cu 5 axe! Acest lucru asigura utilizarea nelimitata si cu o durata optimizata a uneltei. Canelurile mari cu profil in fasii netede garanteaza indepartarea perfecta a rezidurilor, chiar si in materiale care genereaza span lung. Performanta excelenta in otel, aluminiu, materiale plastice si lemn.

	Ø (mm)	Se preteaza pentru	PQ	MOQ	Cod comanda	Cod de bare
<b>ACOPERIRE HSS, DIN 13 H6</b>						
 	6,3	M3	1	1	780121	8717574055658
	8,3	M4	1	1	780122	8717574055665
	10,4	M5	1	1	780123	8717574055672
	12,4	M6	1	1	780124	8717574055689
	16,5	M8	1	1	780125	8717574055696
	20,5	M10	1	1	780126	8717574055702
 	12,4/16,5/20,5	M6/M8/M10	5	1	780128	8717574055719
	6,3/8,3/10,4/12,4/16,5/20,5	M3/M4/M5/ M6/M8/M10	8	1	780129	8717574055726

# PROLINE

## BURGHIE COMBI

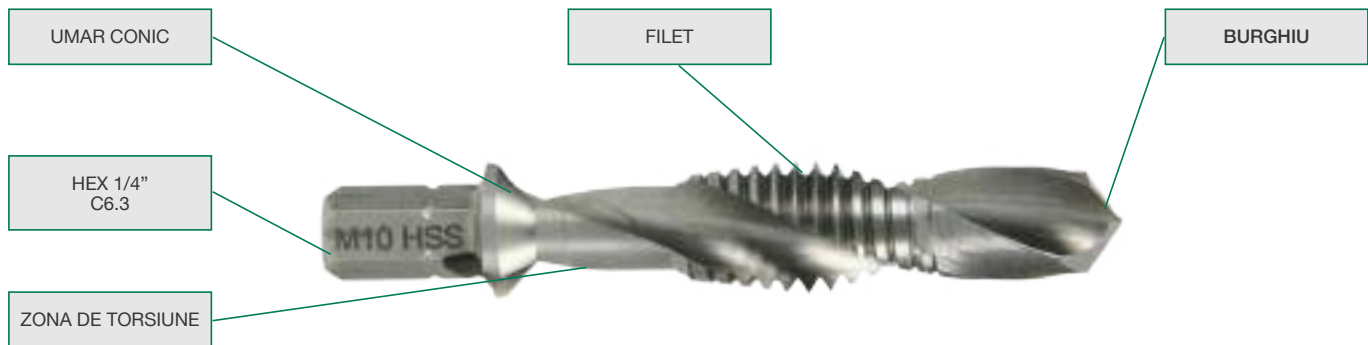

Burghiele brevetate Proline Combi sunt proiectate pentru a gauri - fileta - finisa intr-o singura procedura. Burghiul se preteaza pentru a fi folosit cu masinile cu acumulator, mai ales datorita conexiunii hexagonale 1/4". O zona de torsiune tra-

tata termic cu inductie creste rezistenta la indoire si, prin urmare, creste durata de viata. Burghiele de gaurit combi sunt foarte usor de utilizat. Cu toate acestea, va rugam sa va asigurati ca dupa gaurirea in profunzimea dorita, masinaria electrica s-a

oprit complet. Schimbati sensul de rotatie si rulati foarte incet pentru a va asigura ca burghiul iese complet din piesa prelucrata, fara a deteriora filetul.

	Ø (mm)	Lungime utila (mm)	PQ	MOQ	Cod comanda	Cod de bare
 	M3	6,5	1	1	780131	8717574055733
	M4	9	1	1	780132	8717574055740
	M5	10	1	1	780133	8717574055757
	M6	12	1	1	780134	8717574055764
	M8	15	1	1	780135	8717574055771
	M10	18	1	1	780136	8717574055788
	M12	18	1	1	780137	8717574055795
	M3/M4/M5/M6/M8/M10 Port bit ne-magnetic		7	1	780139	8717574055801

FILIERA						
	Descriere	Filet	PQ	MOQ	Cod comanda	Cod de bare
	Pentru curatarea filetului dupa gaurire trebuie sa utilizam o filiera. Introduceti burghiul combi in filiera si rotiti-o.	M6	1	1	780141	8717574057980
		M8	1	1	780142	8717574057997
		M10	1	1	780143	8717574058000

Se preteaza la utilizare in combinatie cu masinile de taiat cuie: Hikoki CL10D(2), CL10SA, CL14DSL, CL18DSL



# PROLINE

## BURGHIE CAROTA PENTRU METAL

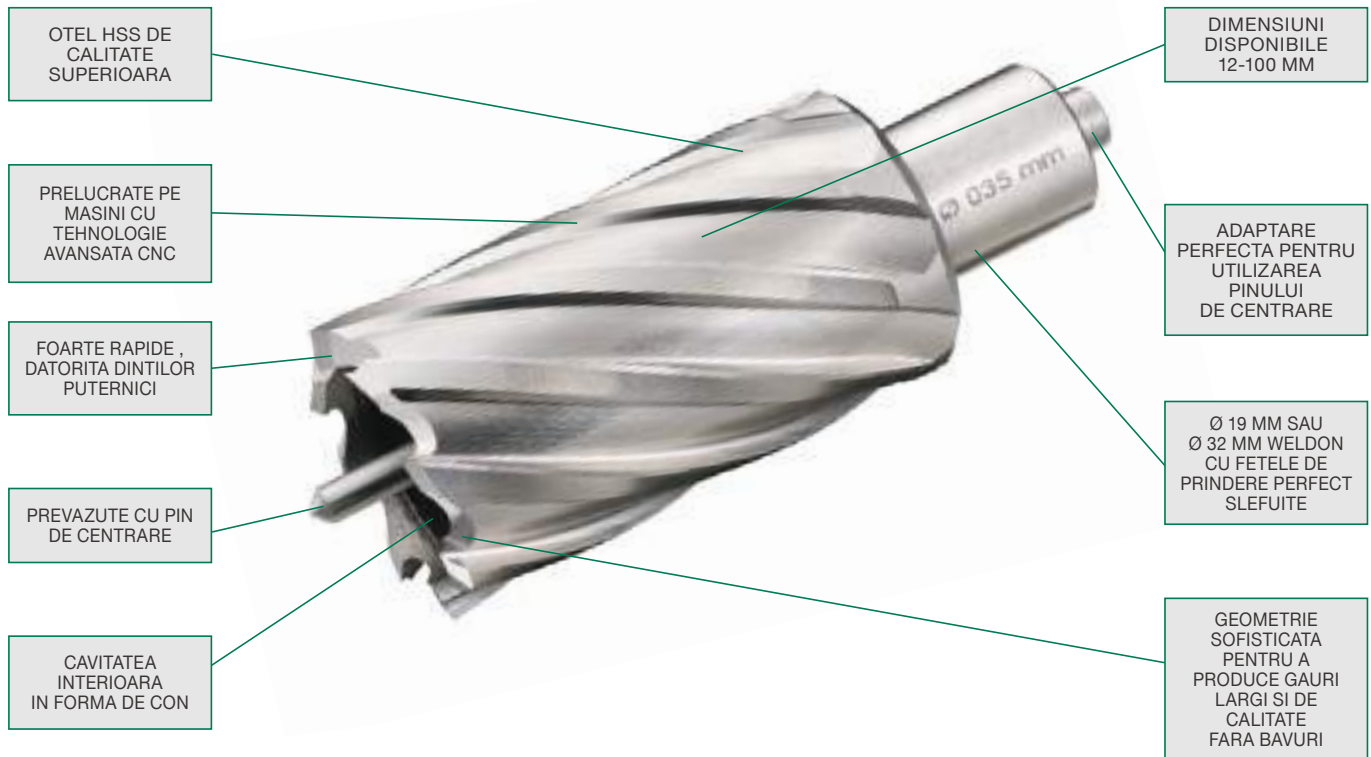

OTEL HSS DE CALITATE SUPERIOARA

PRELUCRATE PE MASINI CU TEHNOLOGIE AVANSATA CNC

FOARTE RAPIDE, DATORITA DINTILOR PUTERNICI

PREVAZUTE CU PIN DE CENTRARE

CAVITATEA INTERIOARA IN FORMA DE CON

DIMENSIUNI DISPONIBILE 12-100 MM

ADAPTARE PERFECTA PENTRU UTILIZAREA PINULUI DE CENTRARE

Ø 19 MM SAU Ø 32 MM WELDON CU FETELE DE PRINDERE PERFECT SLEFUITE

GEOMETRIE SOFISTICATA PENTRU A PRODUCE GAURI LARGI SI DE CALITATE FARA BAVURI

### HSS Burghie carota pentru metal.

Gaurirea cu burghie carota HSS Hikoki este o modalitate eficienta de a face gauri cu diametrul de la 12 la 100 mm. Beneficiile majore la folosirea burghiilor carota Hikoki sunt:

1. In timp ce un sfredel aschiază și elimină tot materialul, carota aschiază și elimină numai materialul ce delimitează inelul de contur al gaurii.
2. Carotele pentru metal sunt mult mai rapide deoarece au mai multe muchii de taiere fata de un burghiu care are doar doua.
3. Gaurirea cu carote pentru metal nu necesita pregătire.
4. Gaurirea cu carote pentru metal elimină mult mai puțin material rezidual deci puterea necesara gauririi este mult mai mica.
5. Cu burghiile carota Hikoki este posibilă și confortabilă efectuarea de jumătăți de gauri și gauri în conducte.

Folosind burghiile carota Hikoki obținem maximum de randament din partea masinii dumneavoastra de gaurit. Carotele pentru metal Hikoki sunt apreciate în întreaga lume pentru performanțe optime, durabilitate, durată lungă de viață și cea mai mare viteză de gaurire.

La Hikoki, calitatea și siguranța în exploatare au cea mai mare prioritate în proiectarea și testarea accesoriilor de mulți ani.



Acest lucru este cu atât mai valabil atunci când se referă la proiectarea și producția de burghie carota pentru metal. Acestea au la baza un oțel HSS de calitate superioară prelucrat pe mașini de înaltă tehnologie CNC. Aliajul de bază este tenace și asigură un risc redus de rupere. Un sistem complet de control al calitatii în fiecare etapă de producție conferă produsului tău cele mai înalte standarde de calitate.

Hikoki va oferi o gamă largă de burghie carota în două lungimi, pentru utilizare în metal și, ocazional, în oțel inoxidabil. Ele sunt utilizate pe scară largă în construcții, transporturi, industria petrolieră și în diverse alte industrii.



### Caracteristici:

1. Sunt perfect stabile, începutul gauririi se face exact fără alunecare pe suprafața piesei prelucrate.
2. Centrare perfectă a gaurii asigurată de pinul de centrare
3. Perfect calibrate la axul de prindere
4. Rapiditate în operare, muchii aschietoare multiple
5. Frezare tronconică a interiorului peretelui ceea ce conferă îndepărtarea simplă a materialului rezidual.



**CAROTE SCURTE**

	$\varnothing$ (mm)	Lungime totala (mm)	Lungime utila (mm)	PQ	MOQ	Cod comanda	Cod de bare
	12	65	30	1	1	754401	8717574030884
	13	65	30	1	1	754402	8717574030891
	14	65	30	1	1	754403	8717574030907
	15	65	30	1	1	754404	8717574030914
	16	65	30	1	1	754405	8717574030921
	17	65	30	1	1	754406	8717574030938
	18	65	30	1	1	754407	8717574030945
	19	65	30	1	1	754408	8717574030952
	20	65	30	1	1	754409	8717574030969
	21	65	30	1	1	754410	8717574030976
	22	65	30	1	1	754411	8717574030983
	22,23	65	30	1	1	754412	8717574030990
	23	65	30	1	1	754413	8717574031003
	24	65	30	1	1	754414	8717574031010
	25	65	30	1	1	754415	8717574031027
	25,40	65	30	1	1	754416	8717574031034
	26	65	30	1	1	754417	8717574031041
	27	65	30	1	1	754418	8717574031058
	28	65	30	1	1	754419	8717574031065
	29	65	30	1	1	754420	8717574031072
	30	65	30	1	1	754421	8717574031089
	31	65	30	1	1	754422	8717574031096
	32	65	30	1	1	754423	8717574031102
	33	65	30	1	1	754424	8717574031119
	34	65	30	1	1	754425	8717574031126
	35	65	30	1	1	754426	8717574031133
	36	65	30	1	1	754427	8717574031140
	37	65	30	1	1	754428	8717574031157
	38	65	30	1	1	754429	8717574031164
	39	65	30	1	1	754430	8717574031171
40	65	30	1	1	754431	8717574031188	
41	65	30	1	1	754432	8717574031195	
42	65	30	1	1	754433	8717574031201	
43	65	30	1	1	754434	8717574031218	
44	65	30	1	1	754435	8717574031225	
45	65	30	1	1	754436	8717574031232	
46	65	30	1	1	754437	8717574031249	
47	65	30	1	1	754438	8717574031256	
48	65	30	1	1	754439	8717574031263	
49	65	30	1	1	754440	8717574031270	
50	65	30	1	1	754441	8717574031287	

**CAROTE SCURTE**

	Ø (mm)	Lungime totala (mm)	Lungime utila (mm)	PQ	MOQ	Cod comanda	Cod de bare
 	51	65	30	1	1	754442	8717574031294
	52	65	30	1	1	754443	8717574031300
	53	65	30	1	1	754444	8717574031317
	54	65	30	1	1	754445	8717574031324
	55	65	30	1	1	754446	8717574031331
	56	65	30	1	1	754447	8717574031348
	57	65	30	1	1	754448	8717574031355
	58	65	30	1	1	754449	8717574031362
	59	65	30	1	1	754450	8717574031379
	60	65	30	1	1	754451	8717574031386

**CAROTE SCURTE**

	Ø (mm)	Lungime totala (mm)	Lungime utila (mm)	PQ	MOQ	Cod comanda	Cod de bare
 	61	65	30	1	1	754452	8717574031393
	62	65	30	1	1	754453	8717574031409
	63	65	30	1	1	754454	8717574031416
	64	65	30	1	1	754455	8717574031423
	65	65	30	1	1	754456	8717574031430
	66	65	30	1	1	754457	8717574031447
	67	65	30	1	1	754458	8717574031454
	68	65	30	1	1	754459	8717574031461
	69	65	30	1	1	754460	8717574031478
	70	65	30	1	1	754461	8717574031485
	71	65	30	1	1	754462	8717574031492
	72	65	30	1	1	754463	8717574031508
	73	65	30	1	1	754464	8717574031515
	74	65	30	1	1	754465	8717574031522
	75	65	30	1	1	754466	8717574031539
	76	65	30	1	1	754467	8717574031546
	77	65	30	1	1	754468	8717574031553
	78	65	30	1	1	754469	8717574031560
	79	65	30	1	1	754470	8717574031577
	80	65	30	1	1	754471	8717574031584
	81	65	30	1	1	754472	8717574031591
	82	65	30	1	1	754473	8717574031607
	83	65	30	1	1	754474	8717574031614
	84	65	30	1	1	754475	8717574031621
	85	65	30	1	1	754476	8717574031638
	86	65	30	1	1	754477	8717574031645
	87	65	30	1	1	754478	8717574031652
	88	65	30	1	1	754479	8717574031669
	89	65	30	1	1	754480	8717574031676
	90	65	30	1	1	754481	8717574031683
	91	65	30	1	1	754482	8717574031690
	92	65	30	1	1	754483	8717574031706
	93	65	30	1	1	754484	8717574031713
	94	65	30	1	1	754485	8717574031720
	95	65	30	1	1	754486	8717574031737
	96	65	30	1	1	754487	8717574031744
	97	65	30	1	1	754488	8717574031751
	98	65	30	1	1	754489	8717574031768
	99	65	30	1	1	754490	8717574031775
	100	65	30	1	1	754491	8717574031782



Diametrele ≤ 50 mm sunt disponibile in stoc. Diametrele > 50 mm sunt disponibile doar la cerere.

CAROTE LUNGI

	Ø (mm)	Lungime totala (mm)	Lungime utila (mm)	PQ	MOQ	Cod comanda	Cod de bare
	12	85	55	1	1	754501	8717574031799
	13	85	55	1	1	754502	8717574031805
	14	85	55	1	1	754503	8717574031812
	15	85	55	1	1	754504	8717574031829
	16	85	55	1	1	754505	8717574031836
	17	85	55	1	1	754506	8717574031843
	18	85	55	1	1	754507	8717574031850
	19	85	55	1	1	754508	8717574031867
	20	85	55	1	1	754509	8717574031874
	21	85	55	1	1	754510	8717574031881
	22	85	55	1	1	754511	8717574031898
	23	85	55	1	1	754512	8717574031904
	24	85	55	1	1	754513	8717574031911
	25	85	55	1	1	754514	8717574031928
	26	85	55	1	1	754515	8717574031935
	27	85	55	1	1	754516	8717574031942
	28	85	55	1	1	754517	8717574031959
	29	85	55	1	1	754518	8717574031966
	30	85	55	1	1	754519	8717574031973
	31	85	55	1	1	754520	8717574031980
	32	85	55	1	1	754521	8717574031997
	33	85	55	1	1	754522	8717574032000
	34	85	55	1	1	754523	8717574032017
	35	85	55	1	1	754524	8717574032024
	36	85	55	1	1	754525	8717574032031
	37	85	55	1	1	754526	8717574032048
	38	85	55	1	1	754527	8717574032055
	39	85	55	1	1	754528	8717574032062
	40	85	55	1	1	754529	8717574032079
	41	85	55	1	1	754530	8717574032086
	42	85	55	1	1	754531	8717574032093
	43	85	55	1	1	754532	8717574032109
	44	85	55	1	1	754533	8717574032116
	45	85	55	1	1	754534	8717574032123
	46	85	55	1	1	754535	8717574032130
	47	85	55	1	1	754536	8717574032147
	48	85	55	1	1	754537	8717574032154
	49	85	55	1	1	754538	8717574032161
	50	85	55	1	1	754539	8717574032178



### CAROTE LUNGI

	Ø (mm)	Lungime totala (mm)	Lungime utila (mm)	PQ	MOQ	Cod comanda	Cod de bare
 	51	85	55	1	1	754540	8717574032185
	52	85	55	1	1	754541	8717574032192
	53	85	55	1	1	754542	8717574032208
	54	85	55	1	1	754543	8717574032215
	55	85	55	1	1	754544	8717574032222
	56	85	55	1	1	754545	8717574032239
	57	85	55	1	1	754546	8717574032246
	58	85	55	1	1	754547	8717574032253
	59	85	55	1	1	754548	8717574032260
	60	85	55	1	1	754549	8717574032277

### CAROTE LUNGI

	Ø (mm)	Lungime totala (mm)	Lungime utila (mm)	PQ	MOQ	Cod comanda	Cod de bare
 	61	85	55	1	1	754550	8717574032284
	62	85	55	1	1	754551	8717574032291
	63	85	55	1	1	754552	8717574032307
	64	85	55	1	1	754553	8717574032314
	65	85	55	1	1	754554	8717574032321
	66	85	55	1	1	754555	8717574032338
	67	85	55	1	1	754556	8717574032345
	68	85	55	1	1	754557	8717574032352
	69	85	55	1	1	754558	8717574032369
	70	85	55	1	1	754559	8717574032376
	71	85	55	1	1	754560	8717574032383
	72	85	55	1	1	754561	8717574032390
	73	85	55	1	1	754562	8717574032406
	74	85	55	1	1	754563	8717574032413
	75	85	55	1	1	754564	8717574032420
	76	85	55	1	1	754565	8717574032437
	77	85	55	1	1	754566	8717574032444
	78	85	55	1	1	754567	8717574032451
	79	85	55	1	1	754568	8717574032468
	80	85	55	1	1	754569	8717574032475
	81	85	55	1	1	754570	8717574032482
	82	85	55	1	1	754571	8717574032499
	83	85	55	1	1	754572	8717574032505
	84	85	55	1	1	754573	8717574032512
	85	85	55	1	1	754574	8717574032529
	86	85	55	1	1	754575	8717574032536
	87	85	55	1	1	754576	8717574032543
	88	85	55	1	1	754577	8717574032550
	89	85	55	1	1	754578	8717574032567
	90	85	55	1	1	754579	8717574032574
	91	85	55	1	1	754580	8717574032581
	92	85	55	1	1	754581	8717574032598
	93	85	55	1	1	754582	8717574032604
	94	85	55	1	1	754583	8717574032611
	95	85	55	1	1	754584	8717574032628
	96	85	55	1	1	754585	8717574032635
	97	85	55	1	1	754586	8717574032642
	98	85	55	1	1	754587	8717574032659
	99	85	55	1	1	754588	8717574032666
	100	85	55	1	1	754589	8717574032673

Diametrele ≤ 50 mm sunt disponibile in stoc. Diametrele > 50 mm sunt disponibile doar la cerere.

## Functionarea pinului de centrare

Positionarea: Pozitionati centrul pin-ului exact la semn. Comutati magnetul pe pozitia on si totul este gata de foraj.





Ungerea: Prin ungerea interna automata, uleiul pentru lubrifierea taieturii este furnizat prin intermediul pin-ului de centrare in cantitatea potrivita.

Ejectarea: In etapa finala, pin-ul de centrare, precomprimat cu ajutorul unui arc, impinge carota afara din gaura.

### ACCESORII CAROTE METAL

	Descriere	PQ	MOQ	Cod comanda	Cod de bare
	Pin centrare scurt 6,35 x 79 mm	1	1	754495	8717574032772
	Pin centrare lung 6,35 x 102 mm	1	1	754594	8717574032789

### CAROTE METAL SETURI

	Continut	PQ	MOQ	Cod comanda	Cod de bare
	7-Buc 2 x 14 x 30 mm 2 x 18 x 30 mm 2 x 22 x 30 mm Pin centrare L = 79 mm	7	1	754496	8717574032796
	8-Buc 14 x 30 mm 14 x 55 mm 18 x 30 mm 18 x 55 mm 22 x 30 mm 22 x 55 mm Pin centrare L = 79 mm Pin centrare L = 102 mm	8	1	754497	8717574033861
	7-Buc 12 x 30 mm 14 x 30 mm 16 x 30 mm 18 x 30 mm 22 x 30 mm 26 x 30 mm Pin centrare L = 79 mm	7	1	754498	8717574033878
	7-Buc 12 x 55 mm 14 x 55 mm 16 x 55 mm 18 x 55 mm 22 x 55 mm 26 x 55 mm Pin centrare L = 102 mm	7	1	754499	8717574033885

# PROLINE

## BURGHIE PENTRU LEMN CV



Toate burghiile Hikoki pentru gaurit lemn sunt fabricate conform standardelor Hikoki din aliaj de otel Cr-V de înalta calitate.

Burghiile pentru lemn au un cap de gaurit cu varf conic de centrare si doua muchii taietoare. Multumita varfului central extrem de ascutit centrarea se face usor si precis. Cele doua puncte exterioare asigura taierea fibrei lemnului rezultand astfel gauri bine finisate.

Burghiile de lemn Hikoki sunt de calitate

profesionala si nu trebuie sa lipseasca din trusa de instrumente a oricarui profesionist in domeniu.

Pe langa prinderea cilindrica, Hikoki va ofera burghie pentru lemn cu prindere hexagonala 1/4" conform ISO 1173 E6.3. Acestea sunt ideale pentru utilizarea pe masini cu prindere hexagonala ce asigura o schimbare mai rapida a burghiilor si o fixare mai buna în mandrina.

Aceste burghie sunt fabricate din materiale

dure.

Hikoki ofera, de asemenea, seturi cu o varietate de diametre astfel încât dimensiunile cele mai comune sa fie disponibile.

BURGHIE PENTRU LEMN CV

	Ø (mm)	Lungime totala (mm)	Lungime utila (mm)	PQ	MOQ	Cod comanda	Cod de bare
	3	61	32	1	1	781901	8717574029697
	4	75	45	1	1	781902	8717574029703
	5	86	50	1	1	781903	8717574029710
	6	92	55	1	1	781904	8717574029727
	7	109	75	1	1	781905	8717574029734
	8	117	75	1	1	781906	8717574029741
	9	125	80	1	1	781907	8717574029758
	10	133	85	1	1	781908	8717574029765



BURGHIE PENTRU LEMN CV PRINDERE REDUSA 10 MM



d = 10 mm	Ø (mm)	Lungime totala (mm)	Lungime utila (mm)	PQ	MOQ	Cod comanda	Cod de bare
	11	142	95	1	1	781909	8717574029772
	12	150	95	1	1	781910	8717574029789
	13	150	95	1	1	781911	8717574029796
	14	150	100	1	1	781912	8717574029802
	15	160	105	1	1	781913	8717574029819
	16	160	105	1	1	781914	8717574029826
	18	180	120	1	1	781915	8717574029833
	20	180	120	1	1	781916	8717574029840



BURGHIE PENTRU LEMN CV PRINDERE REDUSA 13 MM

d = 13 mm	Ø (mm)	Lungime totala (mm)	Lungime utila (mm)	PQ	MOQ	Cod comanda	Cod de bare
	22	180	120	1	1	781917	8717574029857
	24	200	140	1	1	781918	8717574029864
	25	200	140	1	1	781919	8717574029871
	26	200	140	1	1	781920	8717574029888
	28	200	140	1	1	781921	8717574029895
	30	200	140	1	1	781922	8717574029901



BURGHIE PENTRU LEMN CV							
	Ø (mm)	Lungime totala (mm)	Lungime utila (mm)	PQ	MOQ	Cod comanda	Cod de bare
	6	250	140	1	1	781931	8717574029918
	8	250	140	1	1	781932	8717574029925
	10	250	140	1	1	781933	8717574029932
BURGHIE PENTRU LEMN CV PRINDERE REDUSA 10 MM							
	12	250	140	1	1	781934	8717574029949
	14	250	140	1	1	781935	8717574029956
	16	250	140	1	1	781936	8717574029963
	18	250	140	1	1	781937	8717574029970
	20	250	140	1	1	781938	8717574029987

BURGHIE PENTRU LEMN CV 1/4" HEXAGON							
	Ø (mm)	Lungime totala (mm)	Lungime utila (mm)	PQ	MOQ	Cod comanda	Cod de bare
 	2	55	20	1	1	781941	8717574029994
	3	65	35	1	1	781942	8717574030006
	4	75	40	1	1	781943	8717574030013
	5	85	50	1	1	781944	8717574030020
	6	90	55	1	1	781945	8717574030037
	7	90	55	1	1	781946	8717574030044
	8	90	55	1	1	781947	8717574030051
	9	100	60	1	1	781948	8717574030068
	10	100	60	1	1	781949	8717574030075
	11	100	60	1	1	781950	8717574030082
	12	110	65	1	1	781951	8717574030099
	13	110	65	1	1	781952	8717574030105
	14	120	70	1	1	781953	8717574030112
	15	120	70	1	1	781954	8717574030129

BURGHIE PENTRU LEMN CV SETURI						
	Descriere	PQ	MOQ	Cod comanda	Cod de bare	
	5-Buc 4, 5, 6, 8, 10 mm	5	1	781981	8717574030136	
	8-Buc 3, 4, 5, 6, 7, 8, 9, 10 mm	8	1	781982	8717574030143	

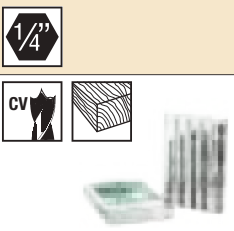
BURGHIE PENTRU LEMN CV SETURI 1/4" HEXAGON						
	Descriere	PQ	MOQ	Cod comanda	Cod de bare	
	5-Buc 4, 5, 6, 8, 10 mm	5	1	781983	8717574030150	

## BURGHIE PENTRU LEMN CV

# PROLINE

## BURGHIE ELICOIDALE PENTRU LEMN



Burghiile elicoidale Hikoki sunt potrivite pentru aproape toate tipurile de lemn.

Designul non-axis de proiectare a spiralei burghiului confera acesteia o capacitate mare de avans in material si implicit de evacuare a materialului rezidual.

Varful de centrare are forma conica autofiletanta care prin rotire avanseaza singur in lemn si faciliteaza centrarea gaurii.

Burghiul este de tip autoforant - avanseaza singur in material astfel încât frecarea este reduca în timpul forajului.

Datorita faptului ca forta de patrundere este usurata de forma burghiului, patrunderea acestuia nu necesita viteza mare de rotatie si nici nu se confrunta cu rezistenta mare a lemnului, creste durata de viata a burghiului dar si a masinii.

Acest burghiu intruneste profesionalismul si calitatea la care te astepti de la Hikoki!

Este potrivit pentru orice tip de lemn, dur sau moale si chiar bun pentru a fi utilizat în lemn umed.

Gama Hikoki cuprinde o mare varietate de diametre si burghiile sunt disponibile în lungimi de 230, 320, 460 si 620 mm.



Hikoki ofera, de asemenea, seturi cu o varietate de diametre astfel încât dimensiunile cele mai comune sa fie disponibile.

Toate burghiile elicoidale sunt prevazute cu prindere hexagonala pentru o prindere mai puternica in falcie mandrinelor.

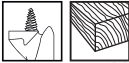

Dimensiunile prinderilor hexagonale sunt cele de mai jos:

Ø Gaura (mm)	Mandrina (mm)
6 – 8	6
9 – 11	10
12 – 36	13

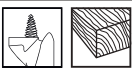

### BURGHIE ELICOIDALE PENTRU LEMN

	Ø (mm)	Lungime totala (mm)	Lungime utila (mm)	PQ	MOQ	Cod comanda	Cod de bare
 	6	230	150	1	1	781801	8717574027785
	7	230	150	1	1	781802	8717574027792
	8	230	150	1	1	781803	8717574027808
	9	230	150	1	1	781804	8717574027815
	10	230	150	1	1	781805	8717574027822
	11	230	150	1	1	781806	8717574027839
	12	230	150	1	1	781807	8717574027846
	13	230	150	1	1	781808	8717574027853
	14	230	150	1	1	781809	8717574027860
	15	230	150	1	1	781810	8717574027877
	16	230	150	1	1	781811	8717574027884
	17	230	150	1	1	781812	8717574027891
	18	230	150	1	1	781813	8717574027907
	19	230	150	1	1	781814	8717574027914
	20	230	150	1	1	781815	8717574027921
	21	230	150	1	1	781816	8717574027938
	22	230	150	1	1	781817	8717574027945
	23	230	150	1	1	781818	8717574027952
	24	230	150	1	1	781819	8717574027969
	25	230	150	1	1	781820	8717574027976
	26	230	150	1	1	781821	8717574027983
	28	230	150	1	1	781822	8717574027990
	30	230	150	1	1	781823	8717574028003
	32	230	150	1	1	781824	8717574028010
	34	230	150	1	1	781825	8717574028027
	35	230	150	1	1	781826	8717574028034
	36	230	150	1	1	781827	8717574028041

**BURGHIE ELICOIDALE PENTRU LEMN**

	<b>Ø (mm)</b>	<b>Lungime totala (mm)</b>	<b>Lungime utila (mm)</b>	<b>PQ</b>	<b>MOQ</b>	<b>Cod comanda</b>	<b>Cod de bare</b>
 	6	320	240	1	1	781831	8717574028058
	8	320	240	1	1	781832	8717574028065
	10	320	240	1	1	781833	8717574028072
	11	320	240	1	1	781834	8717574028089
	12	320	240	1	1	781835	8717574028096
	13	320	240	1	1	781836	8717574028102
	14	320	240	1	1	781837	8717574028119
	15	320	240	1	1	781838	8717574028126
	16	320	240	1	1	781839	8717574028133
	18	320	240	1	1	781840	8717574028140
	20	320	240	1	1	781841	8717574028157
	22	320	240	1	1	781842	8717574028164
	24	320	240	1	1	781843	8717574028171
	26	320	240	1	1	781844	8717574028188
	28	320	240	1	1	781845	8717574028195
	30	320	240	1	1	781846	8717574028201
	32	320	240	1	1	781847	8717574028218
36	320	240	1	1	781848	8717574028225	

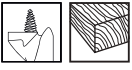
**BURGHIE ELICOIDALE PENTRU LEMN**

	<b>Ø (mm)</b>	<b>Lungime totala (mm)</b>	<b>Lungime utila (mm)</b>	<b>PQ</b>	<b>MOQ</b>	<b>Cod comanda</b>	<b>Cod de bare</b>
 	6	460	380	1	1	781851	8717574028232
	7	460	380	1	1	781852	8717574028249
	8	460	380	1	1	781853	8717574028256
	9	460	380	1	1	781854	8717574028263
	10	460	380	1	1	781855	8717574028270
	11	460	380	1	1	781856	8717574028287
	12	460	380	1	1	781857	8717574028294
	13	460	380	1	1	781858	8717574028300
	14	460	380	1	1	781859	8717574028317
	15	460	380	1	1	781860	8717574028324
	16	460	380	1	1	781861	8717574028331
	17	460	380	1	1	781862	8717574028348
	18	460	380	1	1	781863	8717574028355
	19	460	380	1	1	781864	8717574028362
	20	460	380	1	1	781865	8717574028379
	21	460	380	1	1	781866	8717574028386
	22	460	380	1	1	781867	8717574028393
	23	460	380	1	1	781868	8717574028409
	24	460	380	1	1	781869	8717574028416
	25	460	380	1	1	781870	8717574028423
	26	460	380	1	1	781871	8717574028430
28	460	380	1	1	781872	8717574028447	
30	460	380	1	1	781873	8717574028454	
32	460	380	1	1	781874	8717574028461	
34	460	380	1	1	781875	8717574028478	
35	460	380	1	1	781876	8717574028485	
36	460	380	1	1	781877	8717574028492	

**BURGHIE ELICOIDALE PENTRU LEMN**

**BURGHIE ELICOIDALE PENTRU LEMN**

	Ø (mm)	Lungime totala (mm)	Lungime utila (mm)	PQ	MOQ	Cod comanda	Cod de bare
	6	620	540	1	1	781881	8717574029451
	8	620	540	1	1	781882	8717574029468
	10	620	540	1	1	781883	8717574029475
	11	620	540	1	1	781884	8717574029482
	12	620	540	1	1	781885	8717574029499
	13	620	540	1	1	781886	8717574029505
	14	620	540	1	1	781887	8717574029512
	15	620	540	1	1	781888	8717574029529
	16	620	540	1	1	781889	8717574029536
	18	620	540	1	1	781890	8717574029543
	20	620	540	1	1	781891	8717574029550
	22	620	540	1	1	781892	8717574029567
	24	620	540	1	1	781893	8717574029574
	26	620	540	1	1	781894	8717574029581
	28	620	540	1	1	781895	8717574029598
	30	620	540	1	1	781896	8717574029604
	32	620	540	1	1	781897	8717574029611
36	620	540	1	1	781898	8717574029628	

**BURGHIE ELICOIDALE PENTRU LEMN SETURI**

	Descriere	PQ	MOQ	Cod comanda	Cod de bare
	6-Buc 6, 8, 10, 12, 14, 16 mm L = 230 mm	6	1	781991	8717574029635
	6-Buc 10, 12, 14, 16, 18, 20 mm L = 230 mm	6	1	781992	8717574029642
	8-Buc 10, 12, 14, 16, 18, 20, 22, 24 mm L = 230 mm	8	1	781993	8717574029659
	6-Buc 6, 8, 10, 12, 14, 16 mm L = 460 mm	6	1	781994	8717574029666
	6-Buc 10, 12, 14, 16, 18, 20 mm L = 460 mm	6	1	781995	8717574029673
	8-Buc 10, 12, 14, 16, 18, 20, 22, 24 mm L = 460 mm	8	1	781996	8717574029680

# PROLINE

## BURGHIE PLATE PENTRU LEMN

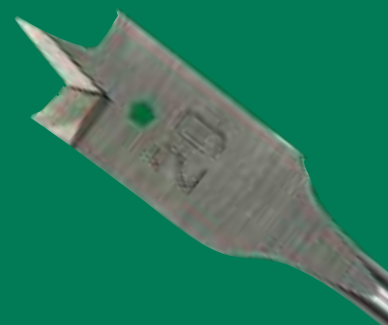

Toate burghiile plate Hikoki pentru lemn sunt fabricate în conformitate cu standardele stricte impuse de Hikoki și sunt realizate din oțel carbon de înaltă calitate cu duritate mare.

Datorită oțelului de înaltă calitate și durității sale burghiile plate pentru lemn pot fi utilizate în toate tipurile de lemn.

Capul de gaurit este echipat cu trei puncte de atac, cel din mijloc asigură centrarea

exactă a găurii iar cele exterioare asigură aschieria precisă a materialului.

Toate burghiile plate Hikoki pentru lemn au prindere hexagonală de 1/4" în conformitate cu ISO 1173 E6.3. Sunt ideale pentru utilizarea pe mașini cu prindere hexagonală ce asigură schimbarea rapidă a burghiilor.



Hikoki oferă, de asemenea, seturi interesante, cu o varietate de diametre, astfel încât cele mai comune dimensiuni să fie

disponibile.





Gama include burghie de găurit plate pentru lemn cu o lungime de 152 mm și 400 mm. În plus, este disponibilă și o piesă de extensie cu o lungime de 300 mm.

Pentru utilizatorii intensivi sunt disponibile seturi avantajoase de 10 bucăți.





BURGHIE PLATE PENTRU LEMN CU PRINDERE 1/4" HEXAGONALĂ

	Ø (mm)	Lungime totală (mm)	PQ	MOQ	Cod comandă	Cod de bare
	6	150	1	1	781701	8717574027006
	8	150	1	1	781702	8717574027013
	10	150	1	1	781703	8717574027020
	12	150	1	1	781704	8717574027037
	13	150	1	1	781705	8717574027044
	14	150	1	1	781706	8717574027051
	15	150	1	1	781707	8717574027068
	16	150	1	1	781708	8717574027075
	17	150	1	1	781709	8717574027082
	18	150	1	1	781710	8717574027099
	19	150	1	1	781711	8717574027105
	20	150	1	1	781712	8717574027112
	22	150	1	1	781713	8717574027129
	24	150	1	1	781714	8717574027136
	25	150	1	1	781715	8717574027143
	26	150	1	1	781716	8717574027150
	28	150	1	1	781717	8717574027167
	30	150	1	1	781718	8717574027174
	32	150	1	1	781719	8717574027181
	34	150	1	1	781720	8717574027198
	35	150	1	1	781721	8717574027204
	36	150	1	1	781722	8717574027211
	38	150	1	1	781723	8717574027228
	40	150	1	1	781724	8717574027235



**BURGHIE PLATE PENTRU LEMN CU PRINDERE 1/4" HEXAGONALA**

	$\emptyset$ (mm)	Lungime totala (mm)	PQ	MOQ	Cod comanda	Cod de bare
  	6	400	1	1	781731	8717574027242
	8	400	1	1	781732	8717574027259
	10	400	1	1	781733	8717574027266
	12	400	1	1	781734	8717574027273
	13	400	1	1	781735	8717574027280
	14	400	1	1	781736	8717574027297
	15	400	1	1	781737	8717574027303
	16	400	1	1	781738	8717574027310
	17	400	1	1	781739	8717574027327
	18	400	1	1	781740	8717574027334
	19	400	1	1	781741	8717574027341
	20	400	1	1	781742	8717574027358
	22	400	1	1	781743	8717574027365
	24	400	1	1	781744	8717574027372
	25	400	1	1	781745	8717574027389
	26	400	1	1	781746	8717574027396
	28	400	1	1	781747	8717574027402
	30	400	1	1	781748	8717574027419
	32	400	1	1	781749	8717574027426
	34	400	1	1	781750	8717574027433
35	400	1	1	781751	8717574027440	
36	400	1	1	781752	8717574027457	
38	400	1	1	781753	8717574027464	
40	400	1	1	781754	8717574027471	







**BURGHIE PLATE PENTRU LEMN CU PRINDERE 1/4" HEXAGONALA 10 BUCATI**

 10x	$\emptyset$ (mm)	Lungime totala (mm)	PQ	MOQ	Cod comanda	Cod de bare
  	6	150	10	1	781761	8717574027488
	8	150	10	1	781762	8717574027495
	10	150	10	1	781763	8717574027501
	12	150	10	1	781764	8717574027518
	13	150	10	1	781765	8717574027525
	14	150	10	1	781766	8717574027532
	15	150	10	1	781767	8717574027549
	16	150	10	1	781768	8717574027556
	17	150	10	1	781769	8717574027563
	18	150	10	1	781770	8717574027570
	19	150	10	1	781771	8717574027587
	20	150	10	1	781772	8717574027594
	22	150	10	1	781773	8717574027600
	24	150	10	1	781774	8717574027617
	25	150	10	1	781775	8717574027624
	26	150	10	1	781776	8717574027631
	28	150	10	1	781777	8717574027648
	30	150	10	1	781778	8717574027655
	32	150	10	1	781779	8717574027662
	34	150	10	1	781780	8717574027679
35	150	10	1	781781	8717574027686	
36	150	10	1	781782	8717574027693	
38	150	10	1	781783	8717574027709	
40	150	10	1	781784	8717574027716	

ACCESORII PENTRU BURGHIE PLATE PENTRU LEMN CU PRINDERE 1/4" HEXAGONALA

	Descriere	PQ	MOQ	Cod comanda	Cod de bare
	Prelungitor pentru burghie plate pentru lemn cu prindere hexagonala 1/4" L = 300 mm Pentru utilizare cu burghie plate pentru lemn > Ø 16 mm	1	1	781790	8717574027723

BURGHIE PLATE PENTRU LEMN 1/4" PRINDERE HEXAGONALA SETURI

	Descriere	PQ	MOQ	Cod comanda	Cod de bare
	6-Buc 12, 14, 16, 18, 20, 22 mm L = 150 mm	6	1	781791	8717574027730
	6-Buc 13, 16, 19, 20, 22, 25 mm L = 150 mm	6	1	781792	8717574027747
	6-Buc 14, 16, 18, 20, 22, 24 mm L = 150 mm	6	1	781793	8717574027754
	13-Buc 6, 8, 10, 12, 13, 14, 16, 17, 18, 19, 20, 22, 25 mm L = 150 mm	13	1	781794	8717574027754
	13-Buc 6, 8, 10, 12, 13, 14, 16, 17, 18, 19, 20, 22, 25 mm L = 150 mm	13	1	781795	8717574027778



# PROLINE

## BURGHIE PENTRU COFRAJE SI INSTALATII

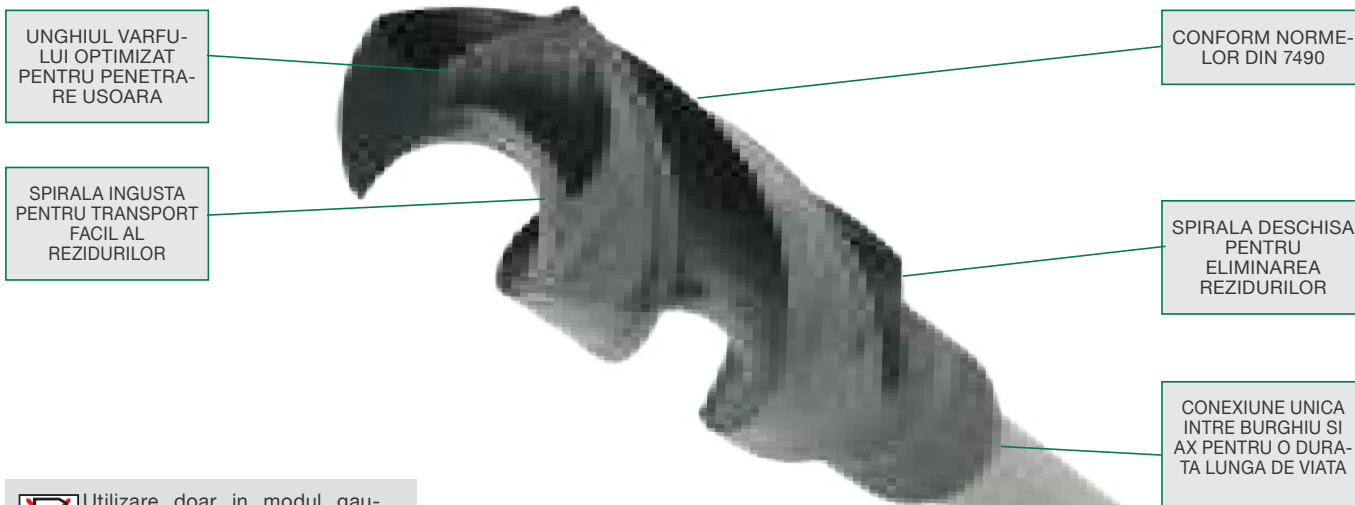

 Utilizare doar in modul gaurire, fara percutie. Dezactivati modul impact.

Pentru gaurire in locuri inguste, asamblarea cofrajelor si spatiile pentru instalatiile sanitare, burghiile Hikoki special concepute pentru astfel de cerinte, sunt indispensabile la fiecare santier. Ele indeplinesc cerintele tehnice si de siguranta ale Asociatiei Profesionale de Comert pentru lemn inregistrat cu norma DIN 7490.



Burghiile sunt fabricate din otel inoxidabil de inalta calitate si permit obtinerea rezultatelor optime de gaurire in lemn, placi de ghips, tencuiala si materiale usoare.



Axul cu conexiune SDS-Plus este calit pentru o durata de viata extinsa a burghiului.



Unghiul superior de 118 ° asigura o penetrare rapida si usoara in material, iar spirala mare deschisa si conica asigura o buna drenare, impiedicand astfel blocarea burghiului, chiar si in lemn umed.



Aplicatii recomandate: Gama larga de aplicatii, atat pentru constructii (cofraje) cat si pentru amenajari interioare, instalatii sanitare, incalzire si instalatii electrice. Cofraje, placi, scanduri, grinzi, gips-carton, materiale de constructii usoare si izolatii.

Instructiuni de utilizare: Folositi masini de gaurit cu mandrina de 13 mm.

	Ø (mm)	Lungime totala (mm)	Lungime utila (mm)	PQ	MOQ	Cod comanda	Cod de bare
 	8	400	350	1	1	4100741	8717574064025
	10	400	350	1	1	4100742	8717574064032
	12	400	350	1	1	4100743	8717574064049
	14	400	350	1	1	4100744	8717574064056
	16	400	350	1	1	4100745	8717574064063
	18	400	350	1	1	4100746	8717574064070
	20	400	350	1	1	4100747	8717574064087
	22	400	350	1	1	4100748	8717574064094
	24	400	350	1	1	4100749	8717574064100

	Ø (mm)	Lungime totala (mm)	Lungime utila (mm)	PQ	MOQ	Cod comanda	Cod de bare
  	8	600	550	1	1	4100751	8717574064117
	10	600	550	1	1	4100752	8717574064124
	12	600	550	1	1	4100753	8717574064131
	14	600	550	1	1	4100754	8717574064148
	16	600	550	1	1	4100755	8717574064155
	18	600	550	1	1	4100756	8717574064162
	20	600	550	1	1	4100757	8717574064179
	22	600	550	1	1	4100758	8717574064186
	24	600	550	1	1	4100759	8717574064193
	26	600	550	1	1	4100760	8717574064209
	28	600	550	1	1	4100761	8717574064216
	30	600	550	1	1	4100762	8717574064223

	Ø (mm)	Lungime totala (mm)	Lungime utila (mm)	PQ	MOQ	Cod comanda	Cod de bare
  	10	400	350	1	1	4100771	8717574064230
	12	400	350	1	1	4100772	8717574064247
	14	400	350	1	1	4100773	8717574064254
	16	400	350	1	1	4100774	8717574064261
	18	400	350	1	1	4100775	8717574064278
	20	400	350	1	1	4100776	8717574064285
	22	400	350	1	1	4100777	8717574064292

	Ø (mm)	Lungime totala (mm)	Lungime utila (mm)	PQ	MOQ	Cod comanda	Cod de bare
  	10	600	550	1	1	4100781	8717574064308
	12	600	550	1	1	4100782	8717574064315
	14	600	550	1	1	4100783	8717574064322
	16	600	550	1	1	4100784	8717574064339
	18	600	550	1	1	4100785	8717574064346
	20	600	550	1	1	4100786	8717574064353
	22	600	550	1	1	4100787	8717574064360
	24	600	550	1	1	4100788	8717574064377
	26	600	550	1	1	4100789	8717574064384
	28	600	550	1	1	4100790	8717574064391
	30	600	550	1	1	4100791	8717574064407

# PROLINE

## BURGHIE FREZA PENTRU LEMN



Calitatea profesionala a burghiilor freza pentru lemn Hikoki este conceputa pentru rezultate precise; este alegerea ideal atunci cand executati gauri oarbe in lemn masiv si materiale din lemn. Margine de taiere periferice (25 - 50 mm) si doua muchii taietoare principale garanteaza gauri fara bavuri, chiar langa margini. Varful central permite pozitio-



narea exacta. Designul este conceput pentru frecare redusa, astfel incat sa se reduca sansele de ardere, imbunatateste durata de viata si permite o forare rapida. Nu este necesara perforarea prealabila a locului operat, sunt concepute pentru pentru gauri oarbe, pentru foraje de margine si foraje inclinate in lemn cu esenta moale si lemn cu esenta

tare. Respecta cerintele in ceea ce priveste calitatea taierii in lemn dur si moale, in furnir si in panouri din lemn stratificat. Gaurire simpla si fara efort datorita geometriei ideale de taiere. Aceste burghie au o prindere rotunda de 9,5 mm, se preteaza pentru mandrine cu prindere de 10 mm.

BURGHIE FREZA PENTRU LEMN

	Ø (mm)	Lungime totala (mm)	PQ	MOQ	Cod comanda	Cod de bare
 	10	90	1	1	4100701	8717574062151
	12	90	1	1	4100702	8717574062168
	14	90	1	1	4100703	8717574062175
	15	90	1	1	4100704	8717574062182
	16	90	1	1	4100705	8717574062199
	18	90	1	1	4100706	8717574062205
	20	90	1	1	4100707	8717574062212
	22	90	1	1	4100708	8717574062229
	24	90	1	1	4100709	8717574062236
	25	90	1	1	4100710	8717574062243
	26	90	1	1	4100711	8717574062250
	28	90	1	1	4100712	8717574062267
	30	90	1	1	4100713	8717574062274
	32	90	1	1	4100714	8717574062281
	34	90	1	1	4100715	8717574062298
	35	90	1	1	4100716	8717574062304
	36	90	1	1	4100717	8717574062311
	38	90	1	1	4100718	8717574062328
	40	90	1	1	4100719	8717574062335
	45	90	1	1	4100720	8717574062342
50	90	1	1	4100721	8717574062359	

BURGHIE FREZA PENTRU LEMN SET

	Descriere	PQ	MOQ	Cod comanda	Cod de bare
 	5-Buc 15, 20, 25, 30, 35 mm	5	1	4100729	8717574062366