



PLINTE & PROFILE

CATALOG
DE **produse**



PLINTE & PROFILE

CATALOG
DE **produse**



Despre noi

SET Prod Com este o companie cu capital integral românesc, având o experiență de peste 20 de ani în producerea și comercializarea plintelor și profilelor pentru sisteme de finisare, în domeniul amenajărilor interioare. Prin gama noastră largă de produse, bazate pe cererea clienților noștri, prin calitatea și diversitatea materialelor create de o echipă de profesioniști, cu experiență în domeniu, vă oferim soluții complete și Sisteme Eficiente la Timp!

Producem și comercializăm o gamă largă de profile din PVC, aluminiu și inox pentru amenajări interioare și construcții, oferindu-vă soluții inedite și complete pentru un finisaj estetic, practic și durabil. Accentul pe detalii este secretul reușitei în amenajări interioare, iar noi suntem conștienți de importanța detaliilor. Tehnologiile avansate, de la proiectare până la producție, pe care le aplicăm, ne oferă suportul necesar pentru atingerea unor standarde de înaltă calitate, și un timp de execuție cât mai scurt.

Suntem foarte flexibili, onorăm și comenzi specifice adică la alte dimensiuni decât cele catalogate.

Asigurăm livrarea produselor, clienților cu care avem relații contractuale, săptămânal, conform programului nostru de încărcare.

Vă stăm la dispoziție, cu o echipă cu experiență și pregătită în domeniu, pentru a vă oferi informații și soluții complete cu cele mai potrivite produse pentru îndeplinirea planurilor dumneavoastră.

Descoperiți soluțiile românești în finisare utilizând Sisteme Eficiente la Timp!

ORBÁN ANDRÁS
director general



About us

SET Prod Com is a Romanian company, with more than 20 years' experience in production, trading of plinths and profiles for finishing systems in the field of interior design. We offer a variety of products based on customer needs, by diversity and quality of materials, created by experienced professionals.

We are producing and trading various PVC, aluminum and stainless steel profiles for interior design and construction, by giving unique and complementary solutions for aesthetic, practical and durable finish.

The emphasis on details is the secret of success in interior design, and we are aware of the importance of details. The advanced technologies, from design to production, that we apply, provide us with the necessary support to achieve high quality standards in a shorter execution time. We are very flexible, we honor specific orders, other than those listed.

We ensure the delivery of our products to customers with whom we have contractual relationships, weekly, according to our logistic schedule.

We are at your disposal, with an experienced team, to provide you with complete information and solutions to fulfill your plans.

Discover Romanian finishing solutions using time efficient systems!

ORBÁN ANDRÁS
general manager



Über uns

SET Prod Com ist ein rumänisches Unternehmen mit mehr als 20 Jahren Erfahrung in der Produktion, und Handel mit Sockeln und Profilen für den Innenausbau. Wir bieten eine breite Palette von Produkten, basierend auf den Anforderungen der Kunden. Die Qualität und Vielfalt der Materialien, werden von einem Team von Fachleuten mit Fachwissen auf dem Gebiet, hergestellt.

Wir produzieren und vertreiben verschiedene Profile aus PVC, Aluminium und Edelstahl für den Innenausbau, indem wir einzigartige und ergänzende Lösungen für ästhetische, praktische und dauerhafte Oberflächen bieten.

Die Betonung der Details ist das Erfolgsgeheimnis in der Innenarchitektur und wir sind uns der Wichtigkeit der Details bewusst. Die von uns eingesetzten fortschrittlichen Technologien vom Entwurf bis zur Produktion geben uns die notwendige Unterstützung, um hohe Qualitätsstandards in kürzerer Ausführungszeit zu erreichen. Wir sind sehr flexibel und erfüllen auch spezifische Aufträge.

Wir stellen sicher, dass unsere Produkte wöchentlich an Kunden geliefert werden, mit denen wir vertragliche Beziehungen haben, gemäß unserem Logistikplan.

Wir stehen Ihnen mit einem erfahrenen Team zur Verfügung, um Ihnen vollständige Informationen und Lösungen für Ihre Pläne zur Verfügung zu stellen.

Entdecken Sie rumänische Finishing-Lösungen mit zeiteffizienten Systemen!

ORBÁN ANDRÁS
general director



◀ **PLINTE DE PARCHET**

SKIRTING BOARDS

SOCKELLEISTE

→ 10.

PROFILE PENTRU GRESIE / FAIANȚĂ ▶

PROFILES FOR CERAMIC TILE FLOORING

SOCKELLEISTE FÜR WANDFLIESEN

34. ←



◀ **PLINTE PENTRU MOCHETĂ**

SKIRTING BOARDS FOR CARPETED FLOORS

SOCKELLEISTE FÜR TEPPICHBODEN

→ 16.

PROFILE PENTRU TREPTE ▶

STAIR NOSING PROFILES

TREPPENKANTEN-PROFILE

50. ←



◀ **PROFILE PENTRU COVER PVC**

SKIRTING BOARDS FOR PVC CARPETED FLOORS

SOCKELLEISTE FÜR PVC-TEPPICH

→ 20.

PROFILE DE TRECERE ▶

CONNECTING PROFILES

ÜBERGANSPROFIL

66. ←

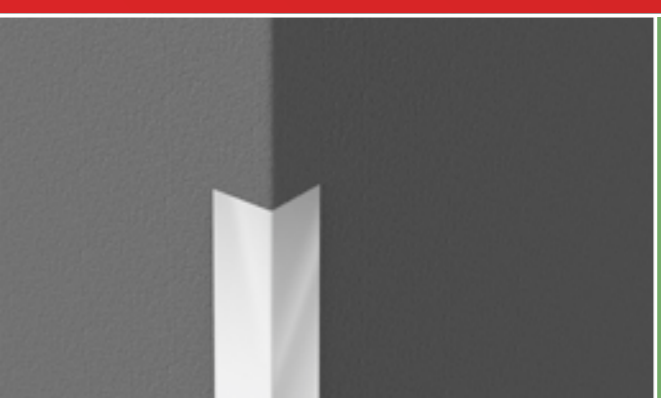
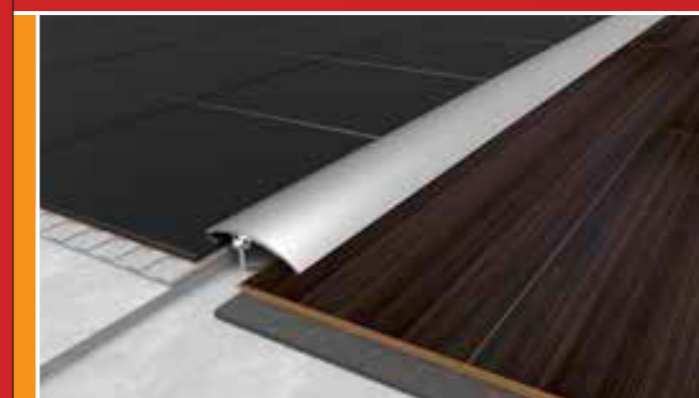

◀ **PROFILE DE COLȚ „L”** **PRODUSE SPECIALE** ▶

„L” SHAPE CORNER PROFILE

L-ECKPROFILE

→ 28.

SPECIAL PRODUCTS

SPEZIELLE PRODUKTE

79. ←



CONȚINUT
CONTENT
INHALT



Plinte de parquet

SKIRTING BOARDS

SOCKELLEISTE

PVC 10456

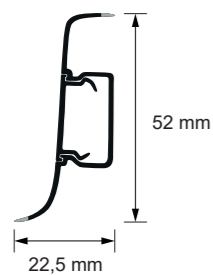

**PLINTĂ CU CANAL CABLU
ȘI MARGINI FLEXIBILE**
PENTRU PARCHET

**PVC SKIRTING BOARD WITH CABLE CHANEL
FOR FLOOR**

**SOCKELLEISTE MIT KABELKANAL
UND FLEXIBLEN KANTEN**
FÜR PARKETTBODEN

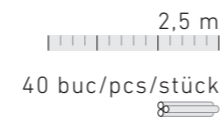

ACCESORII / ACCESSORIES /
ZUBEHÖR



RO Plinta pentru parchet cu canal cablu se folosește pentru finisarea și mascarea rostului de dilatație între parchet și perete. Este dotată cu canal pentru cablu, pentru a ascunde firele electrice inestetice (cablu internet / TV etc.). Marginile flexibile etanșează împotriva prafului și umidității, protejează peretele de zgârieturi / murdărie, cauzate de ex. de aspirator, pantofi, mobilier etc. Este disponibilă într-o gamă largă de culori, pentru a facilita o potrivire perfectă cu parchetul. Marginile flexibile ascund eventualele denivelări ale pereților și podelei.

EN PVC skirting boards with cable ducts are used for finishing and masking the expansion joint between the parquet and the wall. It is equipped with a cable duct to hide the unesthetic electrical wires (cable / TV, etc.). The product has flexible edges that seal against dust and moisture, protecting the wall from scratches/ dirt caused by using the vacuum cleaner. It is available in a wide range of colors to facilitate a perfect match with the parquet. Flexible edges hide any possible wall and floor unevenness.

DE Die Parkettboden-Sockelleiste mit Kabelkanal dient zum Abschluss und Abdecken der Dehnungsfuge zwischen dem Parkettboden und dem Wand. Es ist mit einem Kabelkanal ausgestattet, um die unansehnlichen elektrischen Kabel (Internet-/ TV-Kabel usw.) zu verstecken. Flexible Kanten dichten vor Staub und Feuchtigkeit ab, schützen die Wand vor Kratzern/Verschmutzungen, die z. B. von Staubsauger, Schuhe, Möbel usw. verursacht werden. Ist in zahlreichen Farben erhältlich, um eine perfekte Anpassung an den Parkettboden zu gewährleisten. Flexible Kanten verbergen mögliche Wand- und Bodenunebenheiten.

CULORI / COLOURS / FARBEN

0010	0040	0063	0101	0107	3131	4295	4305	4640	5163
6002	6003	6004	6005	6006	6007	6008	6009	6010	6011
6012	6025	8625	8699	6014	6015	6016	6001		

PVC 25560

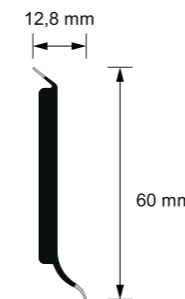

**PLINTĂ SEMIRIGIDĂ CU MARGINI
FLEXIBILE**
PENTRU PARCHET

**SEMI-RIGID SKIRTING BOARD WITH FLEXIBLE EDGES
FOR FLOOR**

HALBSTARRE SOCKELLEISTE MIT FLEXIBLEN KANTEN
FÜR PARKETTBODEN

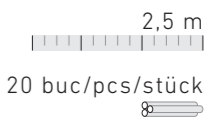

RO Plinta semirigidă cu margini flexibile protejează peretele de zgârieturi / murdărie, prin utilizarea profilului rezultă o suprafață netedă, ușor de curățat. Plinta maschează rostul de dilatație, îmbinare estetică între perete, parchet / covor PVC, iar marginile flexibile protejează împotriva pătrunderii mizeriei.

EN Semi-rigid skirting board with flexible edges with a clear design, used for finishing and masking the expansion joint between the parquet and the wall. It also provides protection against dust and moisture, protects the wall against dirt and blows from the vacuum cleaner or the mop during cleaning. With the accessories one can join the skirting boards perfectly. These products are available in a wide range of colors for a perfect match to the color of the flooring.

DE Halbstarre Sockelleiste mit flexiblen Kanten schützt die Wand vor Kratzern/Schmutz; das Profil führt zu einer glatten, pflegeleichten Oberfläche. Die Sockelleiste maskiert die Dehnungsfuge, bildet eine ästhetische Verbindung zwischen Wand/Parket-/Teppichboden, die flexible Kanten schützen vor dem Eindringen von Schmutz.

CULORI / COLOURS / FARBEN

101	111	0107	0272	1236
-----	-----	------	------	------

PVC 25669

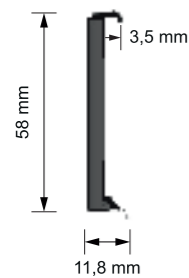

PLINTĂ „DESIGN” (LVT)
PENTRU PARCHET
SKIRTING “DESIGN” PROFILE (LVT)
FOR FLOOR
SOCKELLEISTE (LVT)
FÜR DESIGNPARKETT

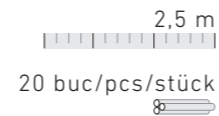

RO Sistem de terminație estetică pentru parchet design, protejează peretele de zgârieturi, disponibilă într-o gamă largă de culori, pentru a facilita o potrivire perfectă cu parchet design PVC.

EN The Design floor closing profile is a complex assembly-facilitating system that can be used to aesthetically create a floor skirting. The board protects against scratches and dirt during cleaning and everyday use.

DE Ästhetisches Abschlussystem für Designparkett, schützt die Wand vor Kratzern und ist in zahlreichen Farben erhältlich, um eine perfekte Anpassung an das PVC-Designparkett zu ermöglichen.

CULORI / COLOURS / FARBEN

0101 5309 0865 0272

AL S78

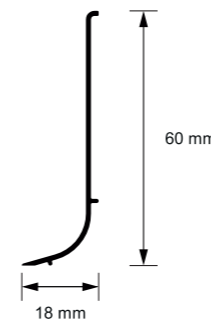

PINTĂ DIN ALUMINIU
PENTRU PARCHET
ALUMINIUM SKIRTING BOARD
FOR FLOOR
ALUMINIUM-SOCKELLEISTE
FÜR PARKETTBODEN

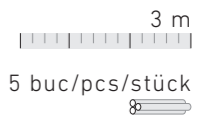

RO Plinta din aluminiu este o plintă cu un design modern, cu finisaj pe diferite culori anodizate, și se poate folosi pentru finisarea pardoselilor acoperite cu parchet, mochetă sau plăci de marmura. Este adecvată pentru birouri, hoteluri și alte locuri publice. Datorită înălțimii de 60 mm, arată bine și în spații mari și protejează pereții de murdărie și zgârieturi cauzate de scaune, aspiratoare, etc.

EN Aluminium skirting boards have a modern design, finished in matt silver, champagne and bronze. They can be used to finish ceramic flooring, carpets or marble tiles. They are recommended for offices, hotels and other public places. Thanks to their 60 mm height, they also look good in large spaces and protect the walls from dirt and scratches caused by chairs, vacuum cleaners, etc.

DE Aluminiumsockelleisten sind Leisten mit einem modernen Design, in verschiedenen Eloxalfarben und können für den Abschluss von Parkett-, Teppich- oder Marmorfliesenboden verwendet werden. Sie eignen sich für Büros, Hotels und andere öffentliche Stellen. Dank der Höhe von 60 mm sehen sie auch in großen Räumen gut aus und schützen die Wände vor durch Stühle, Staubsauger usw. verursachten Schmutz und Kratzern.

CULORI / COLOURS / FARBEN

AG SA BR



Plinte pentru mochetă

SKIRTING BOARDS FOR
CARPETED FLOORS

SOCKELLEISTE FÜR
TEPPICHBODEN

PVC 25443

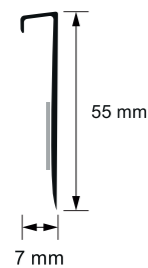

**PLINTĂ FĂRĂ CANAL CABLU
PENTRU MOCHETĂ**
**SKIRTING BOARD WITHOUT CABLE DUCT
FOR CARPET**
**SOCKELLEISTE OHNE KABELKANAL
FÜR TEPPICHBODEN**

2,5 m
40 buc/pcs/stück

ACCESORII / ACCESSORIES /
ZUBEHÖR



RO Plinta pentru mochetă este un sistem de terminație estetică pentru mochete, ce protejează peretele de zgârieturi/murdărie. Îmbinare perfectă între plinte cu ajutorul accesoriilor: colțuri interioare/exterioare și capete. Plinta este disponibilă într-o gamă largă de culori, pentru a facilita o potrivire perfectă cu mocheta.

EN A carpet skirting is an aesthetic finishing system for carpet-covered floors. Once installed, the trim protects the wall from scratches / dirt caused by vacuum cleaners, shoes, furniture, etc. Skirting elements can be joined perfectly with the accessories: inner/outer corners and terminals. These products are available in a wide range of colors to facilitate a perfect fit with the carpet.

DE Sockelleiste für Teppichboden mit Kabelkanal - ästhetisches Abschlussystem für Teppichboden, das die Wand vor Kratzern/Schmutz schützt. Das mit Kabelkanal versehene Modell eignet sich zum Verstecken von unansehnlichen elektrischen Drähten. Perfekte Verbindung zwischen Sockelleisten mit Hilfe des Zubehörs: Innen- / Außenecken. Die Sockelleiste ist in zahlreichen Farben erhältlich, um eine perfekte Anpassung an den Teppich zu ermöglichen.

NEW SYSTEM

ANTIDESPINDERE
ANTI DETACHMENT
FEST MONTIERBAR



CULORI / COLOURS / FARBEN

101 111 295 110 525 1236

22016 CUIE DIN OȚEL
STEEL NAIL
STAHLNÄGEL

100
BUC / PCS
1,5 X 25 mm

PVC 25474

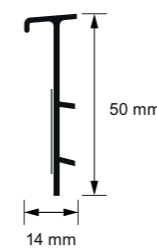

**PLINTĂ CU CANAL CABLU
PENTRU MOCHETĂ**
**SKIRTING BOARD WITH CABLE DUCT
FOR CARPET**
**SOCKELLEISTE MIT KABELKANAL
FÜR TEPPICHBODEN**

2,5 m
40 buc/pcs/stück

ACCESORII / ACCESSORIES /
ZUBEHÖR



RO Plinta pentru mochetă cu canal cablu este un sistem de terminație estetică pentru mochete, ce protejează peretele de zgârieturi/murdărie, modelul cu canal pentru cablu este adecvat pentru a ascunde firele electrice inestetice. Îmbinare perfectă între plinte cu ajutorul accesoriilor: colțuri interioare/exterioare. Plinta este disponibilă într-o gamă largă de culori, pentru a facilita o potrivire perfectă cu mocheta.

EN Carpet skirting boards are an aesthetic finishing system for carpet-covered floors. Once installed, the trim protects the wall from scratches/ dirt caused by vacuum cleaners, shoes, furniture, etc. The cable duct model is suitable for hiding unaesthetic electric wires (cable / TV, etc.). Boards can be joined flawlessly with the help of the accessories: inner / outer corners. These products are available in a wide range of colors to facilitate a perfect match with the carpet.

DE Sockelleiste für Teppichboden mit Kabelkanal, ein ästhetisches Abschlussystem für Teppichboden, das die Wand vor Kratzern/ Schmutz schützt. Das mit Kabelkanal versehene Modell eignet sich zum Verstecken von unansehnlichen elektrischen Drähten. Perfekte Verbindung zwischen Sockelleisten mit Hilfe des Zubehörs: Innen- / Außenecken. Die Sockelleiste ist in zahlreichen Farben erhältlich, um eine perfekte Anpassung an den Teppich zu ermöglichen.

NEW SYSTEM

ANTIDESPINDERE
ANTI DETACHMENT
FEST MONTIERBAR



CULORI / COLOURS / FARBEN

101 111 295 110 525 1236

22018 CUIE DIN OȚEL ZINCAT
STEEL NAIL, GALVANIZED
NÄGEL AUS VERZINKTEM STAHL

100
BUC / PCS
1,5 X 35 mm

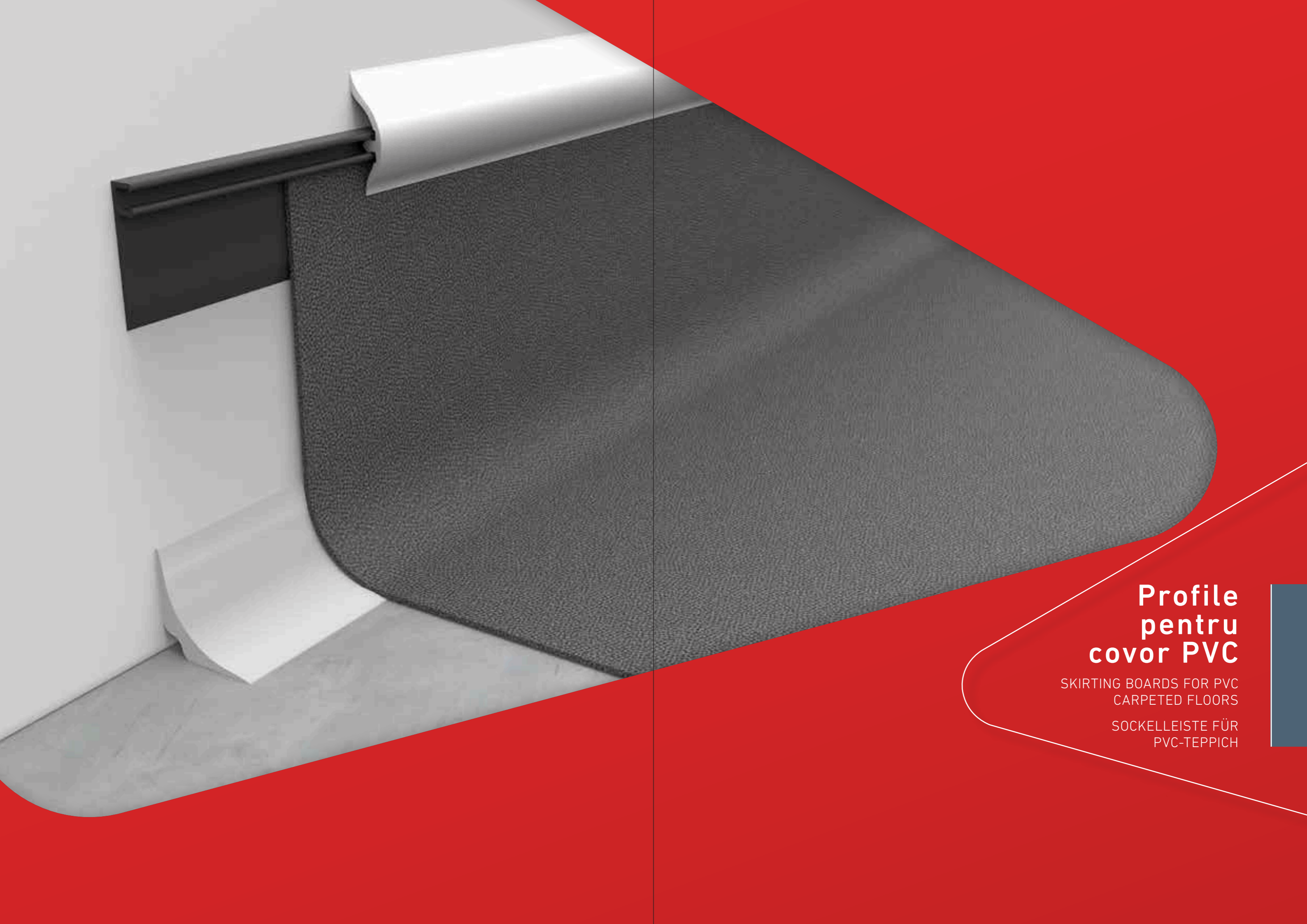

Profile pentru cover PVC

SKIRTING BOARDS FOR PVC
CARPETED FLOORS

SOCKELLEISTE FÜR
PVC-TEPPICH

10310

10333

PVC 10335



50 m / 1
2 buc/pcs/stück

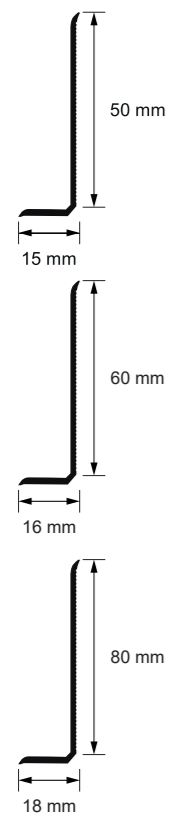

PLINTĂ FLEXIBILĂ
PENTRU COVER PVC
SOFT-PVC SKIRTING BOARD
FOR PVC CARPET
FLEXIBLE SOCKELLEISTE
FÜR TEPPICHBODEN

RO Plintele flexibile sunt o soluție mai economică pentru finisarea marginii pardoselilor și se folosesc mai ales în domeniul profesional. Au rolul de a masca rostul de dilatație și de a proteja peretele de mizerie și zgârieturi, cauzate de ex. de aspirator, pantofi, mobilier etc. Se pot aplica la pardoseli finisate cu linoleum sau parchet laminat și se folosesc mai ales în școli, săli de sport etc. Plintele flexibile se montează cu adeziv, într-un timp mult mai scurt decât plintele obișnuite. Produsul este disponibil în mai multe dimensiuni și într-o gamă largă de culori, inclusiv imitații de lemn.

EN Soft-PVC skirting boards are a more cost-effective floor finishing solution and are mainly used in the professional field. They are meant to mask the expansion joint and protect the wall against scratches/ dirt caused by vacuum cleaners, shoes, furniture, etc. They can be applied to laminated flooring with linoleum or parquet and are used mainly in schools, sports halls, etc. Flexible skirting boards are fitted with adhesive in a much shorter time than ordinary skirting boards. The product is available in various sizes and in a wide range of colors, including wood imitations.

DE Flexible Sockelleisten stellen eine wirtschaftlichere Lösung für Bodenabschluss dar und werden hauptsächlich im professionellen Bereich eingesetzt. Sie haben die Aufgabe, die Dehnungsfuge abzudecken und die Wand vor z.B. von Staubsauger, Schuhe, Möbel usw. verursachten Schmutz und Kratzern zu schützen.

10310

CULORI / COLOURS / FARBEN

101	107	111	1236	295
675	712	3020	4295	525

10333

CULORI / COLOURS / FARBEN

111	295
1236	0107

10335

CULORI / COLOURS / FARBEN

111	295
0107	

10861

PVC 10859

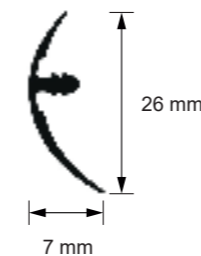

PROFIL ÎNCHIDERE
PENTRU COVER PVC
CLOSING PROFILE
FOR PVC CARPET
TEPPICHABSCHLUSSPROFIL
FÜR TEPPICHBODEN

RO Profilele de scafă pentru cover PVC se folosesc mai ales în domeniul profesional, în locații unde igiena perfectă este foarte importantă.

EN Profiles for PVC carpet are mainly used in the professional field, in places where perfect hygiene is very important. These profiles are recommended for linoleum-covered floors in medical institutes, hospitals, clinics, sanitary facilities and professional kitchens, etc. With the help of these profiles, the linoleum can be partially applied to the wall without forming a corner. The floor will be easy to clean and comply with the hygiene rules.

DE Hohlkehprofile für PVC-Teppiche werden insbesondere im professionellen Bereich an solchen Orten eingesetzt, wo eine perfekte Hygiene sehr wichtig ist.

10861

10859

10861

CULORI / COLOURS / FARBEN

101	1236	2160	675
712	5189		

3 m
100 buc/pcs/stück

10859

BAZĂ PENTRU FIXAREA PROFILULUI
DE ÎNCHIDERE 10861
BASE ELEMENT FOR 10861 PVC CARPET
CLOSING PROFILE
BASISELEMENT ZUR VERLEGUNG
DES ABSCHLUSSPROFILS 10861

1236

3 m
60 buc/pcs/stück

PVC **251610**

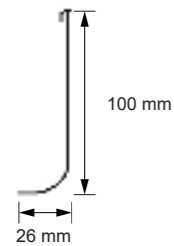

**PROFIL DE SCAFĂ
ȘI ÎNCHIDERE**

PENTRU COVER PVC

**HULL CLOSING PROFILE
FOR PVC CARPET**

**HOHLKEHL- UND
ABSCHLUSSPROFIL
FÜR PVC-TEPPICH**

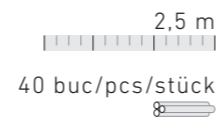

RO Se recomandă utilizarea produsului la montarea covoarelor din PVC din interiorul spitalelor, clinicilor, cabinetelor medicale și ale altor instituții sanitare, unde este necesar să obțineți o suprafață ușor de curățat și de igienizat.

EN Profiles for PVC carpets are mainly used in the professional field, in places where perfect hygiene is very important. These profiles are recommended for linoleum-covered floors in medical institutes, hospitals, clinics, sanitary facilities and professional kitchens, etc. With the help of this profile the linoleum can be partially applied to the wall without forming a corner. The floor will be easy to clean and comply with the hygiene rules.

DE Es wird empfohlen, das Produkt bei der Verlegung von PVC-Teppichen in Krankenhäusern, Kliniken, Arztpraxen und anderen sanitären Einrichtungen zu verwenden, wo eine reinigungsleichte und leicht desinfizierbare Oberfläche erforderlich ist.

20334

PVC **251525**

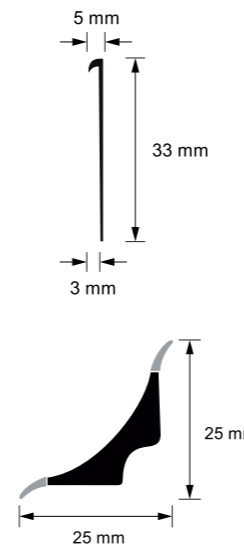

**PROFIL ÎNCHIDERE ȘI PROFIL DE SCAFĂ
CU MARGINE FLEXIBILĂ**

PENTRU COVER PVC

**CLOSING PROFILE AND HULL PROFILE
WITH FLEXIBLE EDGES**

**ABSCHLUSSPROFIL UND HOHLKEHLPROFIL
MIT FLEXIBLEN KANTEN
FÜR PVC-TEPPICH**

RO Recomandăm utilizarea produsului la montarea covoarelor din PVC din interiorul spitalelor, clinicilor, cabinetelor medicale și ale altor instituții sanitare, unde este necesar să obțineți o suprafață ușor de curățat și de igienizat, conform standardelor în vigoare.

EN Profiles for PVC carpets are mainly used in the professional field, in places where perfect hygiene is very important. These profiles are recommended for linoleum-covered floors in medical institutes, hospitals, clinics, sanitary facilities and professional kitchens, etc. With the help of the profile the linoleum can be partially applied to the wall without forming a corner. The floor will be easy to clean and comply with the hygiene rules.

DE Wir empfehlen, das Produkt bei der Verlegung von PVC-Teppichen in Krankenhäusern, Kliniken, Arztpraxen und anderen sanitären Einrichtungen zu verwenden, wo Sie eine leicht zu reinigende und desinfizierbare Oberfläche gemäß den geltenden Normen erhalten müssen.

20334

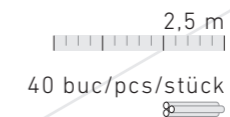

CULORI / COLOURS / FARBEN



251525

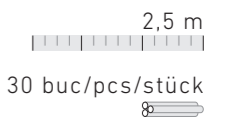

CULORI / COLOURS / FARBEN



PVC 13364

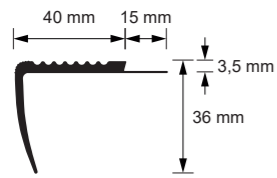

**PROFIL DE TREAPTĂ PENTRU ACOPERIRE,
ÎMBINARE MOCHETĂ / COVER PVC**
DIN PCV FLEXIBIL

**SOFT PVC STAIR NOSING WITH
CARPET CLOSING**
FLEXIBLE PVC

**TREPPENKANTENPROFIL MIT
TEPPICHANSCHLUSS/ -ABSCHLUSS**
WEICH-PVC

3,2 m
10 buc/pcs/stück

RO Aceste profile sunt fabricate din PVC flexibil și au un rol dublu: de a proteja marginile de trepte de deteriorări și de a preveni accidentele prin alunecare. Sunt folosite mai ales în domeniul profesional: spitale, școli, birouri etc. De asemenea, cu ajutorul acestor profile, se pot fixa pe trepte marginile mochetei sau a linoleumului.

CULORI / COLOURS / FARBEN

111 295 525 107

PVC 13420

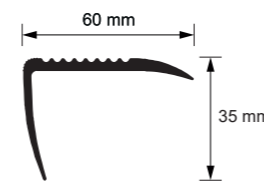

**PROFIL DE TREAPTĂ
DIN PCV FLEXIBIL**

**STAIR NOSING WITH
CARPET CLOSING**
FLEXIBLE PVC

TREPPENPROFIL
WEICH-PVC

3,2 m
10 buc/pcs/stück

EN These profiles are made of flexible PVC and have a dual role: to protect the edges of the stairs from damages and to prevent accidents due to slipping. They are mainly used in the professional field: hospitals, schools, offices, etc. In addition, with these profiles one can also affix the edges of the carpet or linoleum to the stairs.

DE Diese Profile sind aus Weich-PVC und haben eine doppelte Funktion: Schutz der Treppenkanten vor Beschädigungen und Verhinderung von Rutschunfällen. Sie werden hauptsächlich im professionellen Bereich eingesetzt: Krankenhäuser, Schulen, Büros usw. Mit diesen Profilen können auch die Ränder des Teppichs oder Linoleums zu den Treppen befestigt werden.

CULORI / COLOURS / FARBEN

111 295 525 107

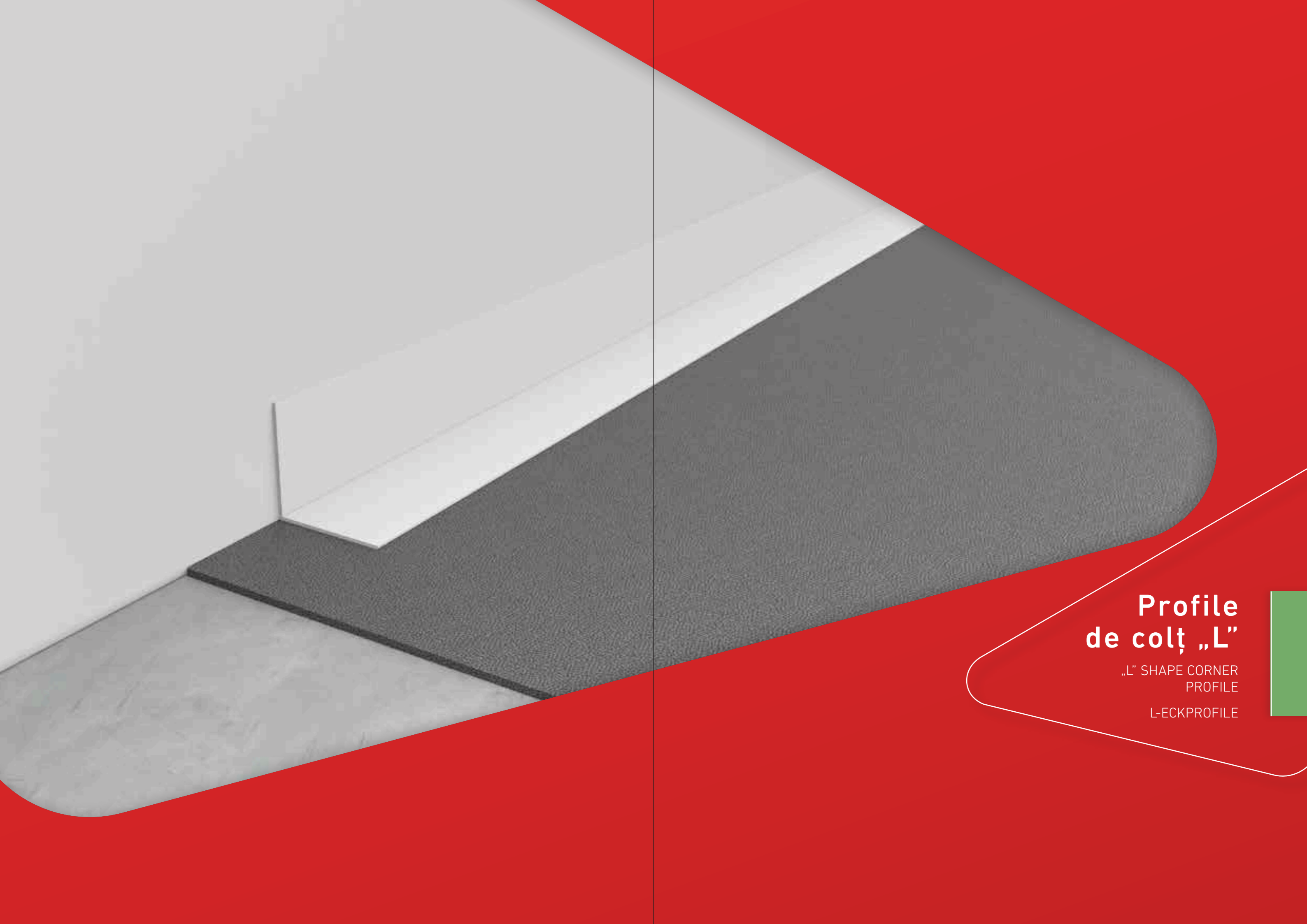

Profile de colț „L”

„L” SHAPE CORNER
PROFILE

L-ECKPROFILE



30122

32017

PVC 32018



30318

PVC 30317



30122
32017
32018

30318
30317

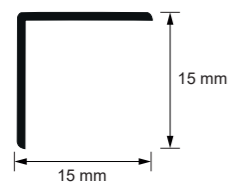

PROFILE DE COLȚ „L”
DIN PVC
„L” SHAPE CORNER PROFILE
PVC
L-ECKPROFILE
AUS PVC

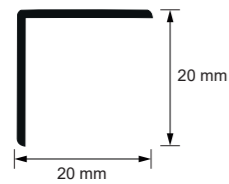

(RO) Profilele de colț se utilizează în locuri cu trafic intens, pentru a proteja colțurile pereților împotriva loviturilor și zgârieturilor. Se montează cu adeziv și poate fi folosit pe tencuială, lambriu, tapet, gresie/faianță, etc

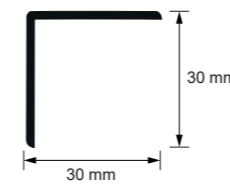
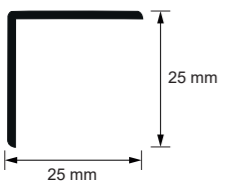

PROFILE DE COLȚ „L”
DIN PVC
„L” SHAPE CORNER PROFILE
PVC
L-ECKPROFILE
AUS PVC

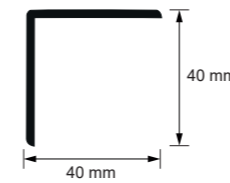

(EN) „L” shape corner profiles are used in places with intense traffic to protect wall corners against scratches, bumps and dirt. They are applied with glue and can be used on plaster, wall paneling, wallpaper, tiles, etc.

(DE) Eckprofile werden in verkehrintensiven Bereichen eingesetzt, um die Ecken der Wände vor Stößen und Kratzern zu schützen. Die Verlegung erfolgt mit Klebstoff und kann auf Putz, Wandverkleidungen, Tapeten, Fliesen usw. verwendet werden.

30122

15 mm

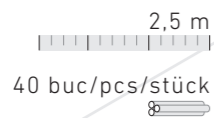

CULORI / COLOURS / FARBEN

101

32017

20 mm

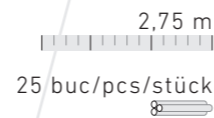

111	1545	H38	H40
H41	H42		

32018

25 mm

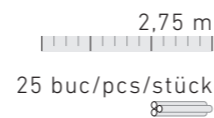

CULORI / COLOURS / FARBEN

1544 1545 8695 8625 H38 H40 H42 H73

30318

30 mm

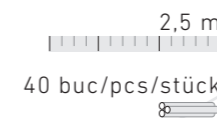

CULORI / COLOURS / FARBEN

101

30317

40 mm

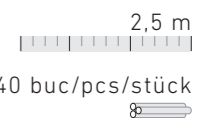

CULORI / COLOURS / FARBEN

101

AL **S25**

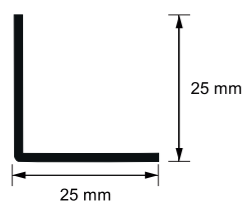

PROFIL DE COLȚ „L”

ALUMINIU

„L” SHAPE CORNER PROFILE

ALUMINIUM

L-ECKPROFIL

ALUMINIUM

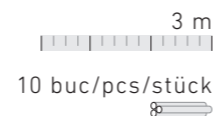

10 buc/pcs/stück

RO Profilele de colț se utilizează în locuri cu trafic intens, pentru a proteja colțurile pereților împotriva loviturilor și zgârieturilor. Se montează cu adeziv și poate fi folosit pe tencuială, lambriu, tapet, gresie/faianță, etc.

EN Corner profiles are used in places with heavy traffic, to protect wall corners against bumps and scratches. They can be applied with adhesive and can be used on plaster, wall paneling, wallpaper, floor/ wall tiles etc.

DE Eckprofile werden in verkehrintensiven Bereichen eingesetzt, um die Ecken der Wände vor Stößen und Kratzern zu schützen. Die Verlegung erfolgt mit Klebstoff und kann auf Putz, Wandverkleidungen, Tapeten, Fliesen usw. verwendet werden.

CULORI / COLOURS / FARBEN

AG AU BR

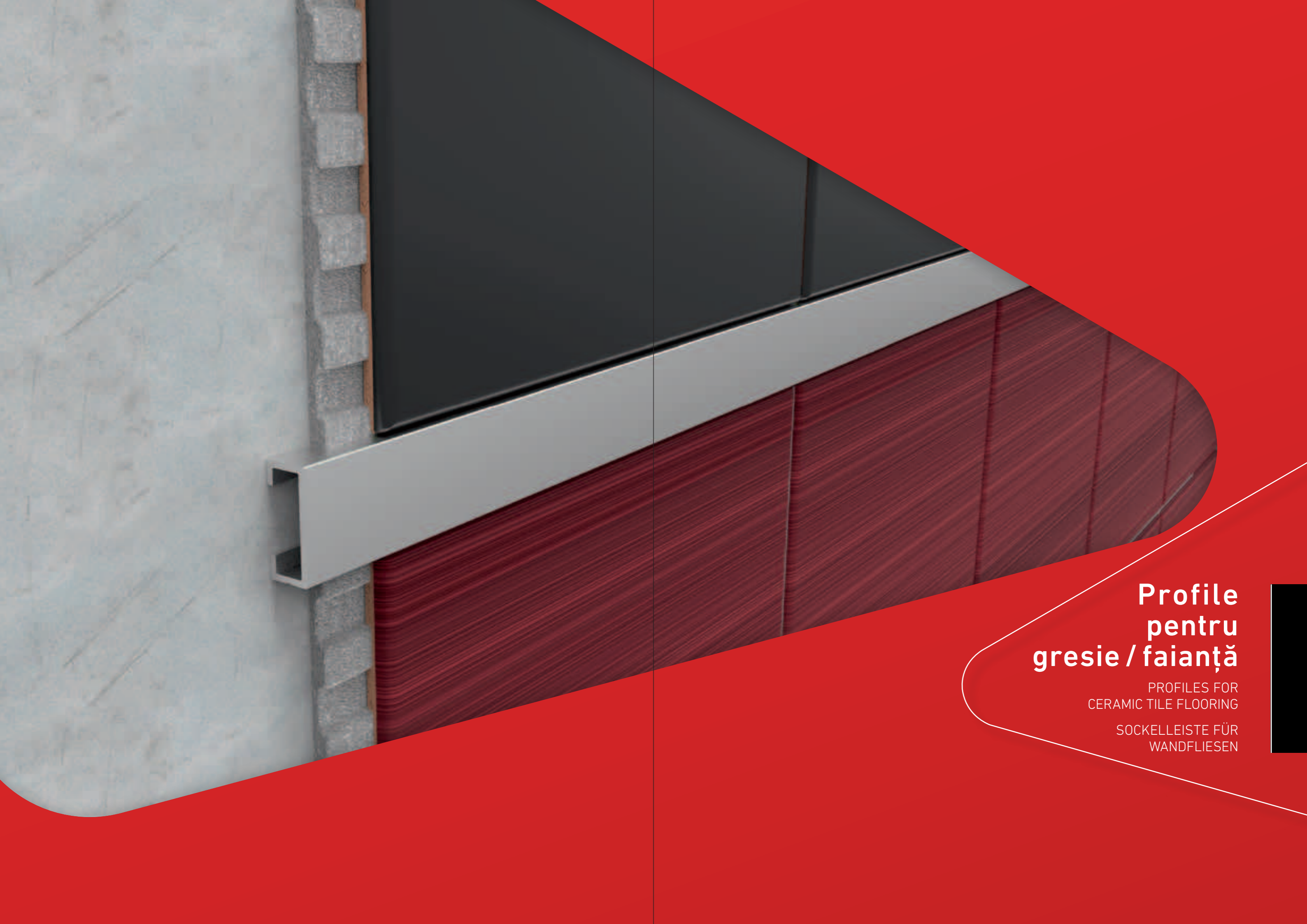

Profile pentru gresie / faianță

PROFILES FOR
CERAMIC TILE FLOORING

SOCKELLEISTE FÜR
WANDFLIESEN

278268

PVC 31318



32101

PVC 32151



278268
31318

32101
32151

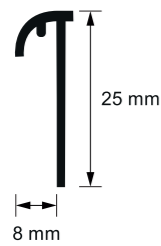

PROFIL COLȚ EXTERIOR
PENTRU FAIANȚĂ
HALF-ROUND TILE-ENDING PROFILE
FOR CERAMIC TILES
AUSSENECKPROFIL
FÜR WANDFLIESEN

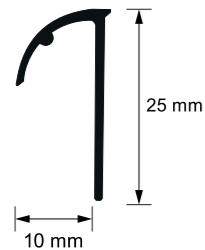

RO Profilele de colț exterior pentru gresie/faianță asigură un finisaj estetic pentru colțurile exterioare ale gresiei/faianței, iar prin forma rotundă atenuează și protejează muchiile plăcilor ceramice. Produsul este disponibil într-o gamă largă de culori, pentru a facilita o potrivire perfectă cu plăcile ceramice.

EN Tile-ending profiles provide an aesthetic finish to the outside corners of the floor tiles/ wall tiles. Their rounded shape protects the edges of ceramic tiles. The product is available in a wide range of colors to facilitate a perfect match with the ceramic tiles.

DE Außeneckprofilen für Fliesenboden und -Wände gewährleisten ein ästhetisches Abschluss für die äußeren Ecken der Fliesen. Die abgerundete Form mildert und schützt die Fliesenkanten. Das Produkt ist in einer Vielzahl von Farben erhältlich, um eine perfekte Anpassung an den Keramikfliesen zu ermöglichen.

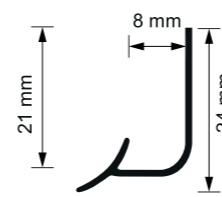

PROFIL COLȚ INTERIOR
PENTRU FAIANȚĂ
INNER CORNER PROFILES
FOR CERAMIC TILES
INNENECKPROFIL
FÜR WANDFLIESEN

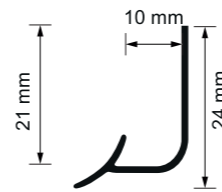

RO Terminație / colț interior pentru îmbinarea suprafețelor finisate cu plăci ceramice. Se utilizează pentru mascarea estetică a muchiilor. Au un finisaj estetic pentru muchiile exterioare de gresie/faianță iar forma rotundă atenuează muchiile ascuțite. Protejează muchiile plăcilor ceramice. Disponibil într-o gamă largă de culori, pentru a facilita o potrivire perfectă cu plăcile ceramice (întâlnirea tavan/perete/pardoseală).

EN Inner corner profiles are used to join ceramic tile surfaces to obtain aesthetically masked tile edges (wall / wall, floor / wall, etc.). The product is available in a wide range of colors to facilitate a perfect match with the ceramic tiles.

DE Abschluss/ Innenecke zum Verbinden von gefliesten Oberflächen. Dient zur ästhetischen Abdeckung von Kanten. Ästhetisches Abschluss für Außenkanten von gefliesten Oberflächen. Die runde Form dämpft scharfe Kanten. Schützt die Kanten von Keramikfliesen. In einer breiten Palette von Farben erhältlich für eine perfekte farbliche Übereinstimmung mit den Keramikfliesen (Decke/ Wand/ Boden- Übergang).

278268 2,78 m
8 mm 18 buc/pcs/stück

31318 2,5 m
10 mm 20 buc/pcs/stück

32101 2,78 m
8 mm 18 buc/pcs/stück

32151 2,5 m
10 mm 20 buc/pcs/stück

CULORI / COLOURS / FARBEN

1015	101	1236
------	-----	------

0101	0107	1015	1236	2030	2105	3020
4030	4040	4295	5003	5004	6012	8016
LT1257	LT1395	PF307	LT1154	LT1256	LT1148	

CULORI / COLOURS / FARBEN

1015	101	1236
------	-----	------

0101	0107	1015	1236	2030	2105	3020
4030	4040	4295	5003	5004	6012	8016
LT1257	LT1395	PF307	LT1154	LT1256	LT1148	

PVC 25188

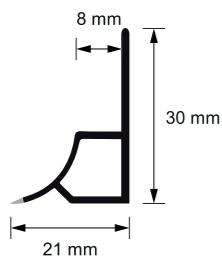

PROFIL COLȚ PENTRU CADĂ
CU SET ACCESORII

BATHTUB SKIRTING
PVC PROFILE
WITH ACCESSORIES

BADEWANNE-ECKPROFIL
MIT ZUBEHÖRSET

2,5 m
10 buc/pcs/stück

RO Profilele pentru cadă se utilizează la îmbinarea între pereții finisați cu faianță și cada / cabina de duș. Cu ajutorul profilelor se poate masca rostul dintre perete și cadă.

EN Bathtub profiles are used to connect tiled walls and bathtubs/shower cabins, providing aesthetically masked tile edges. With the help of these profiles, one can mask the grout line between the wall and the bathtub. By using these profiles one can obtain a smooth, easy-to-clean surface, and they also help prevent mold caused by water accumulation.

DE Die Badewannenprofile dienen zum Anschluss der gefliesten Wände mit der Badewanne/ Duschkabine. Mit Hilfe der Profile kann die Fuge zwischen der Wand und die Badewanne abgedeckt werden.

CULORI / COLOURS / FARBEN

101

PVC 25388

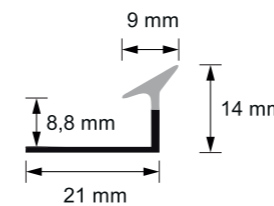

PROFIL COLȚ INTERIOR
PENTRU FAIANȚĂ

FLEXIBIL
INNER CORNER PROFILE
FOR CERAMIC TILES

FLEXIBLE
INNENECKPROFIL
FÜR WANDFLIESEN

2,78 m
18 buc/pcs/stück

RO Profilele de colț interior se utilizează pentru îmbinarea suprafețelor finisate cu plăci ceramice, pentru mascarea estetică a marginilor de faianță/ gresie tăiate (întâlnirea între perete/perete, pardoseală/perete etc.)

EN Flexible inner corner profiles are used to join ceramic tile surfaces in order to obtain aesthetically masked tile edges (wall / wall, floor / wall, etc.). These flexible profilea can be fastened on ceramic surfaces flawlessly, providing a smooth, easy-to-clean surface, and helping to prevent mold due to accumulating water.

DE Inneneckprofile werden zum Anschluss von gefliesten Oberflächen verwendet, um die geschnittene Fliesenkanten ästhetisch abzudecken (Wand/ Wand-oder Boden/Wand-Anschluss usw.).

CULORI / COLOURS / FARBEN

1015

101

PVC 25210

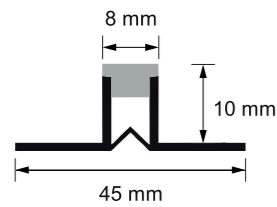

PROFIL DE DILATAȚIE

PENTRU GRESIE

EXPANSION JOINT PROFILES

FOR CERAMIC TILES

DEHNFUGENPROFIL

FÜR FLIESEN

2,5 m
20 buc/pcs/stück

RO Profilele de dilatație pentru gresie se folosesc la suprafețe mari placate cu gresie. Profilul se montează împreună cu gresia, și are rolul de a prelua tensiunile care acționează asupra plăcilor ceramice ca urmare a variațiilor de temperatură și a solicitării de zi cu zi, astfel, preîntâmpinând crăpăturile și dislocarea gresiei. Profilul din PVC se recomandă pentru uz interior în spații cu trafic moderat.

EN PVC expansion joint profiles are used on large tiled surfaces. The profile is mounted simultaneously with the ceramic tiles and has the role of taking over the stress from the surface of the ceramic tiles due to temperature variations and daily use, preventing cracks and the dislodging of the tiles. The PVC profile is recommended for indoor use in moderate traffic areas.

DE Dehnfugenprofile für Fliesen werden auf großen gefliesten Oberflächen verwendet. Das Profil wird zusammen mit der Fliese verlegt und hat die Aufgabe, die Beanspruchungen zu übernehmen, die infolge von Temperaturschwankungen und täglichen Anforderungen auf die Keramikfliesen einwirken, wodurch Risse und die Verschiebung der Fliesen verhindert wird. Das PVC-Profil wird für den Innenbereich in Bereichen mit mittelstarkem Verkehr empfohlen.

CULORI / COLOURS / FARBEN

101 1236 2105

AL

S12

S11



S12
S11

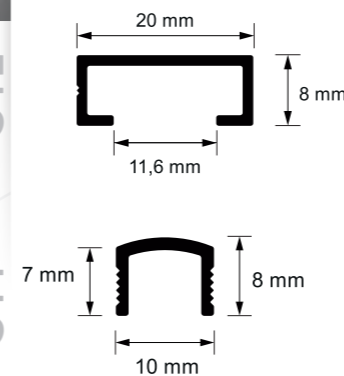

PROFIL DECO LISTELLO

DREPTUNGHIUJAR / BOMBAT

LISTELLO DECORATIVE STRIP

STRAIGHT / ROUNDED

LISTELLO DEKORPROFIL

RECHTECKIG / GERUNDET

3 m
20 buc/pcs/stück

RO Profilele listello au rol decorativ și conferă un plus de eleganță băilor și altor suprafețe acoperite cu faianță. Acestea se montează pe pereții verticali între plăcile de faianță. Poziționarea profilului depinde doar de imaginație: se poate poziționa vertical sau orizontal, se pot monta mai multe profile sau doar unul singur, pot fi folosite pentru a delimita faianțele în diferite culori etc. Se asortează cu robinete, suporturi pentru prosop, etc., cromate sau mate.

EN Our Listello aluminium profiles play a decorative role, adding more elegance to bathrooms and other tiled surfaces. They are mounted on the vertical walls between the tiles. The positioning of the profile is only limited by one's imagination: it can be positioned vertically or horizontally, one can apply several profiles or only one, they can be used to delimit tiles of different colors, etc. They can be matched to taps, towel rails, etc., available in shiny or matte chromed finish.

DE Listello-Profile sehen dekorativ aus und tragen zur Eleganz von Bädern und anderen gefliesten Oberflächen bei. Sie sind an den vertikalen Wänden zwischen den Fliesen zu verlegen. Die Positionierung des Profils hängt nur von Ihrer Vorstellungskraft ab: Es kann vertikal oder horizontal positioniert werden, es können mehrere Profile verlegt werden oder nur eines, sie können zur Abgrenzung von Fliesen in verschiedenen Farben usw. verwendet werden. Sie können an verchromte oder matte Hähne, Handtuchhaltern usw. angepasst werden.

CULORI / COLOURS / FARBEN

AG AX

AL 161123



PROFIL PENTRU DILATAȚIE
CU INSERTIE PVC
EXPANSION JOINT PROFILE
WITH PVC INSERT
DEHNFUGENPROFIL
MIT PVC-EINLAGE

2,5 m
50 buc/pcs/stück

RO Profilele de dilatație pentru gresie se folosesc la suprafețe mari placate cu gresie. Profilul se montează împreună cu gresia, și are rolul de a prelua tensiunile care acționează asupra plăcilor ceramice ca urmare a variațiilor de temperatură și a solicitării de zi cu zi, astfel, preîntâmpinând crăpăturile și dislocarea gresiei. Profilul din aluminiu se recomandă atât pentru uz interior cât și exterior.

EN Aluminium expansion joint profiles are used on large tiled surfaces. Profiles are applied simultaneously with the ceramic tiles and are meant to take over the stress from the surface of the ceramic tiles due to temperature variations and daily use, preventing cracks and the dislodging of the tiles. The aluminium profile is recommended for both indoor and outdoor use.

DE Dehnfugenprofile für Fliesenboden werden auf großen gefliesten Oberflächen verwendet. Das Profil wird zusammen mit der Fliese verlegt und hat die Aufgabe, die Beanspruchungen zu übernehmen, die infolge von Temperaturschwankungen und täglichen Anforderungen auf die Keramikfliesen einwirken, wodurch Risse und die Verschiebung der Fliesen verhindert wird. Das Aluminiumprofil wird sowohl für den Innen- als auch für den Außenbereich empfohlen.

CULORI / COLOURS / FARBEN

GRI NEG

AL S56

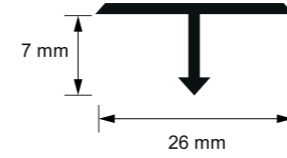
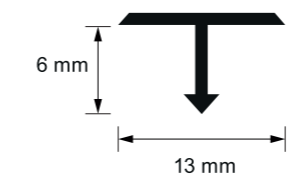

A54
S56

PROFIL „T”
FĂRĂ DIFERENȚĂ DE NIVEL
“T” JOINT CONNECTING PROFILE
FOR FLOORS OF SAME HEIGHT
T-PROFIL AUS
FÜR BODEN MIT GLEICHER HÖHE

RO Profil de trecere între pardoseli din același material de finisaj (gresie/faianță) pentru acoperirea estetică a rostului dintre cele două suprafețe placate la același nivel.

EN Aluminium “T” joint connecting profiles are used between floors covered with the same finishing (floor/wall tiles) to aesthetically cover the grout line between two surfaces that are at the same level.

DE Übergangsprofil zwischen Beläge aus desselben Material (Fliesen) zur ästhetischen Abdeckung der Fugen zwischen den beiden Oberflächen mit gleicher Höhe.

A54

1m, 2,5 m
50 buc/pcs/stück

CULORI / COLOURS / FARBEN

NA

S56

1 m
10 buc/pcs/stück
2 m, 2,5m
50 buc/pcs/stück

NA

S56

2,5 m
50 buc/pcs/stück

CULORI / COLOURS / FARBEN

AG BR OL



S21

AL S53



S50

S51

AL S52



S21
S53

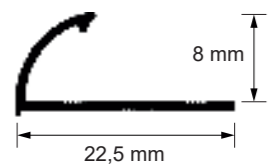

PROFIL DE TERMINAȚIE

ROTUND

TILE-ENDING PROFILE

ROUNDED

ABSCHLUSSPROFIL

ABGERUNDET

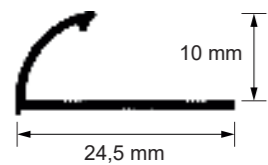

(RO) Profilele de colț exterior pentru gresie/faianță asigură un finisaj estetic pentru colțurile exterioare ale gresiei/faianței, iar prin forma rotundă atenuează și protejează muchiile plăcilor ceramice.

(EN) Aluminium drip edge profiles are used on tiled patios or balconies. They are meant to protect the walls below the profile against water leakage.

(DE) Die Außeneckprofile für Fliesenboden und -Wände gewährleisten ein ästhetischen Abschluss für die äußeren Ecken der Fliesen. Die abgerundete Form mildert und schützt die Fliesenkanten.

S21

8 mm

2,5 m

20 buc/pcs/stück

S53

10 mm

2,5 m

20 buc/pcs/stück

CULORI / COLOURS / FARBEN



S50
S51
S52

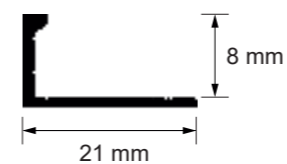

PROFIL DE TERMINAȚIE

DREPT

TILE-ENDING PROFILE

STRAIGHT

ABSCHLUSSPROFIL

ECKIG

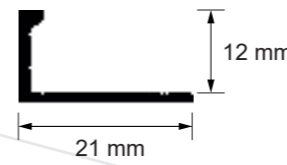
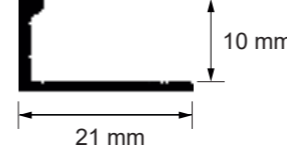

(RO) Profilele de terminație asigură un finisaj estetic pentru muchiile exterioare ale gresiei/faianței și protejează marginile plăcilor ceramice. Sunt disponibile în diferite dimensiuni și nuanțe pentru o potrivire cât mai bună cu nevoile dumneavoastră.

(EN) Tile-ending profiles provide an aesthetic finish to the external edges of the tiles, protecting the edges. They are available in various sizes and shades to better match your needs.

(DE) Abschlussprofile verleihen den Außenkanten von Fliesen ein ästhetischen Abschluss und schützen die Kanten der Keramikfliesen. Sie sind in verschiedenen Größen und Farben erhältlich, um Ihre Bedürfnisse besser zu erfüllen.

S50

8 mm

2,5 m

20 buc/pcs/stück

S51

10 mm

2,5 m

20 buc/pcs/stück

S52

12 mm

2,5 m

20 buc/pcs/stück

CULORI / COLOURS / FARBEN

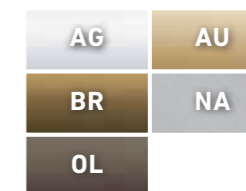
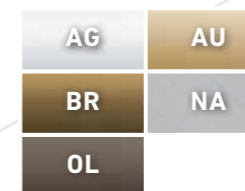
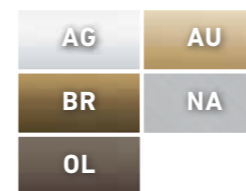

AL S94

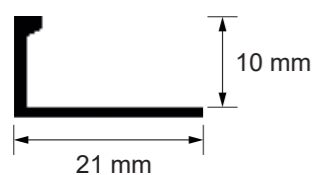

PROFIL DE TERMINAȚIE

ÎNDOIBIL

BENDABLE TILE-ENDING PROFILE
FLEXIBLE

ABSCHLUSSPROFIL
BIEGBAR

2,5 m
20 buc/pcs/stück

RO Profilele de terminație asigură un finisaj estetic pentru muchiile exterioare ale gresiei/faianței și protejează marginile plăcilor ceramice. Sunt disponibile în diferite dimensiuni și nuanțe pentru o potrivire cât mai bună cu nevoile dumneavoastră. Profilul îndoibil oferă o soluție optimă pentru muchii curbate.

EN Tile-ending profiles provide an aesthetic finish to the external edges of tiles, protecting the edges. They are available in various sizes and shades to better match your needs. Bendable profiles provide an optimum solution for curved edges.

DE Abschlussprofile verleihen den Außenkanten der Fliesen einen ästhetischen Abschluss und schützen die Kanten von Keramikfliesen. Sie sind in verschiedenen Größen und Farben erhältlich, um Ihre Bedürfnisse besser zu erfüllen. Das biegbare Profil bietet eine optimale Lösung für gebogene Kanten.

CULORI / COLOURS / FARBEN



AL S88

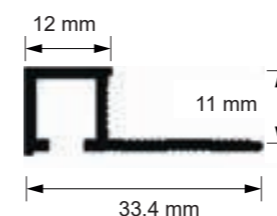

PROFIL DE TERMINAȚIE

PĂTRAT

TILE-ENDING PROFILE
STRAIGHT

ABSCHLUSSPROFIL
RECHTECKIG

2,7 m
10 buc/pcs/stück

RO Profilele de terminație asigură un finisaj estetic pentru muchiile exterioare ale gresiei/faianței și protejează marginile plăcilor ceramice. Sunt disponibile în diferite dimensiuni și nuanțe pentru o potrivire cât mai bună cu nevoile dumneavoastră.

EN Tile-ending profiles provide an aesthetic finish to the external edges of the tiles, protecting the edges. They are available in various sizes and shades to better match your needs.

DE Abschlussprofile verleihen den Außenkanten von Fliesen ein ästhetischen Abschluss und schützen die Kanten der Keramikfliesen. Sie sind in verschiedenen Größen und Farben erhältlich, um Ihre Bedürfnisse besser zu erfüllen.

CULORI / COLOURS / FARBEN



AL **S96**

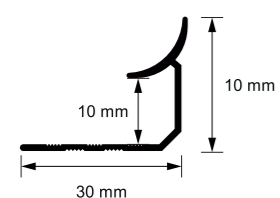

PROFIL COLȚ INTERIOR
 ROTUND
INNER CORNER PROFILE
 ROUNDED
INNENECKPROFIL
 VIERTELKREIS

2,5 m
 10 buc/pcs/stück

RO Profilele de colț interior se utilizează pentru îmbinarea suprafețelor finisate cu plăci ceramice, pentru mascarea estetică a marginilor faianței/gresiei tăiate (întâlnirea perete/perete, pardoseală/perete etc.)

EN Inner corner profiles are used to join tiled surfaces, thus obtaining aesthetically masked tile edges (wall / wall, floor/wall, etc.). The product is available in a wide range of colors to facilitate a perfect match with the ceramic tiles.

DE Inneneckprofile werden zum Anschluss von gefliesten Oberflächen verwendet, um die geschnittene Fliesenkanten ästhetisch abzudecken (Wand/ Wand -oder Böden/Wand-Anschluss usw.).

CULORI / COLOURS / FARBEN



AL **S99**

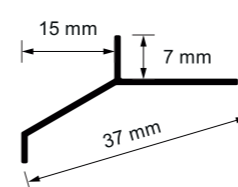

PROFIL PICURĂTOR
 DRIP EDGE PROFILE
 TROPFENPROFIL

2,5 m
 20 buc/pcs/stück

RO Profilul picurător se utilizează la balcoane sau terase finisate cu gresie. Are rolul de a proteja de scurgerile de apă, pereții exteriori aflați sub nivelul profilului.

EN The aluminium drip edge profile is used on tiled patios or balconies. It is meant to protect the walls below the profile against water leakage.

DE Das Tropfenprofil wird auf gefliesten Terrassen oder Balkone verwendet. Es hat die Aufgabe, die Außenwände unterhalb des Profils vor Wasserleckagen zu schützen.

CULORI / COLOURS / FARBEN





Profile pentru trepte

STAIR NOSING PROFILES

TREPPENKANTENPROFILE

AL S59

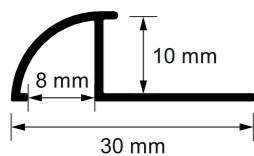

PROFIL DE TERMINAȚIE

ROTUND

TILE-ENDING PROFILE

ROUNDED

ABSCHLUSSPROFIL

VIERTELKREIS

2,5 m
20 buc/pcs/stück

RO Profilele de colț exterior încorporabil pentru gresie/faianță asigură un finisaj estetic pentru colțurile exterioare ale gresiei/faianței, iar prin forma rotundă atenuează și protejează muchiile plăcilor ceramice.

EN Aluminium drip edge profiles are used on tiled patios or balconies. They are meant to protect the walls below the profile against water leakage.

DE Die Außeneckprofile für Fliesenboden und -Wände gewährleisten ein ästhetischen Abschluss für die äußeren Ecken der Fliesen. Die abgerundete Form mildert und schützt die Fliesenkanten.

CULORI / COLOURS / FARBEN

BR

NA

AL S58

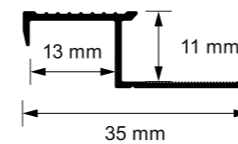

PROFIL ÎNCORPORABIL

DREPT

BUILT-IN NOSING PROFILE

STRAIGHT

TREPPENKANTENPROFILE ZUM EINBAUEN

WINKEL

2,5 m
20 buc/pcs/stück

RO Profilele încorporabile pentru trepte se folosesc la treptele placate cu gresie. Acestea protejează marginile treptelor de deteriorări și le conferă un finisaj elegant. Profilul este prevăzut cu striații, astfel având și rol antiderapant.

EN Built-in Aluminium stair nosing profiles are used for tiled stairs. They protect the edges of the ceramic tiles from breakage, and they provide them an elegant finish. The profile is provided with ribbing, thus also having a non-skid role.

DE Einbaubare Treppenprofile werden bei gefliesten Treppen verwendet. Sie schützen die Kanten der Treppen vor Schäden und verleihen diesen einen eleganten Abschluss. Das Profil ist gerieffelt und bildet somit eine Antirutsch-Sicherung.

CULORI / COLOURS / FARBEN

AU

BR

SA

NA

OL

AL **S81**

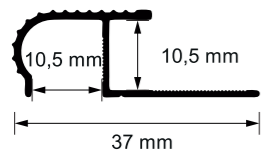

**PROFIL DE TERMINAȚIE
– ÎNCORPORABIL**

ROTUND

BUILT-IN STAIR NOSING PROFILE

ROUNDED

TREPPENKANTENPROFILE ZUM EINBAUEN

VIERTELKREIS

2,5 m
20 buc/pcs/stück

RO Profilele încorporabile pentru trepte se folosesc la treptele placate cu gresie. Acestea protejează marginile treptelor de deteriorări și le conferă un finisaj elegant. Profilul este prevăzut cu striații, astfel având și rol antiderapant.

EN Built-in aluminium stair nosing profiles are used for tiled stairs. They protect the edges of ceramic tiles from breakage and they provide an elegant finish, also having a non-skid role.

DE Einbaubare Treppenprofile werden bei gefliesten Treppen verwendet. Sie schützen die Kanten der Treppen vor Schäden und verleihen diesen einen eleganten Abschluss. Das Profil ist gerieffelt und bildet somit eine Antirutsch-Sicherung.

CULORI / COLOURS / FARBEN

AU BR NA OL

AL **S91**

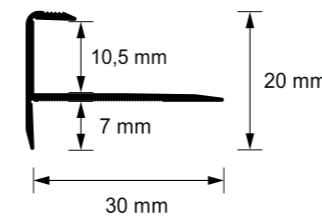

PROFIL PENTRU TREPTE

ÎNDOIBIL

STAIR NOSING PROFILE

BENDABLE

ALUMINIUM TREPPENKANTENPROFIL

BIEGBAR

2,5 m
10 buc/pcs/stück

RO Profilele pentru trepte au rolul de a proteja marginile treptelor de deteriorări. Profilul este prevăzut cu striații, având și rol antiderapant. Aceste profile pot fi folosite la toate treptele, indiferent de finisajul folosit pe suprafața lor.

EN Aluminium stair nosing profiles are designed to protect the edges of the stairs from damages. The profile is provided with ribs, thus also having an anti-skid feature. These profiles can be applied on most surfaces.

DE Treppenprofile schützen die Treppenkanten vor Schäden. Das Profil ist gerieffelt und bildet somit eine Antirutsch-Sicherung. Diese Profile können auf Treppen aller Art verwendet werden, unabhängig von dem verwendeten Treppenbelag.

CULORI / COLOURS / FARBEN

AG AU BR OL

AL S40

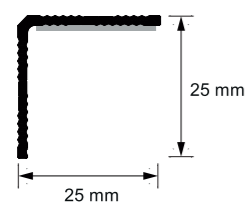
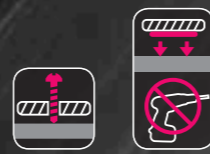

PROFIL PENTRU TREAPTĂ

CU ȘURUB SAU AUTOADEZIV

STAIR NOSING PROFILE

WITH SCREW OR SELF-ADHESIVE

TREPPENKANTENPROFIL

SELBSTKLEBEND ODER ANSCHRAUBBAR

0,9 m, 2,7 m
10 buc/pcs/stück

RO Profilele pentru trepte au rolul de a proteja marginile treptelor de deteriorări. Profilul este prevăzut cu striații, având și rol antiderapant. Aceste profile pot fi folosite la toate treptele, indiferent de finisajul folosit pe suprafața lor.

EN Aluminium stair nosing profiles are designed to protect the edges of the stairs from damages. The profile is provided with ribs, thus also having an anti-skid feature. These profiles can be applied on most surfaces.

DE Treppenprofile schützen die Treppenkanten vor Schäden. Das Profil ist gerieffelt und bildet somit eine Antirutsch-Sicherung. Diese Profile können auf Treppen aller Art verwendet werden, unabhängig von dem verwendeten Treppenbelag.

CULORI / COLOURS / FARBEN



AL S45

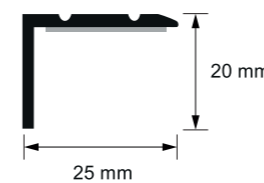

PROFIL PENTRU TREAPTĂ

CU ȘURUB SAU AUTOADEZIV

STAIR NOSING PROFILE

WITH SCREW OR SELF-ADHESIVE

TREPPENKANTENPROFIL

SELBSTKLEBEND ODER ANSCHRAUBBAR

1 m, 3 m
10 buc/pcs/stück

RO Profilele pentru trepte au rolul de a proteja marginile treptelor de deteriorări. Profilul este prevăzut cu striații, având și rol antiderapant. Aceste profile pot fi folosite la toate treptele, indiferent de finisajul folosit pe suprafața lor.

EN Aluminium stair nosing profiles are designed to protect the edges of the stairs from damage. The profile is provided with ribs, thus also having an anti-skid feature. These profiles can be mounted on most surfaces.

DE Treppenprofile schützen die Treppenkanten vor Schäden. Das Profil ist gerieffelt und bildet somit eine Antirutsch-Sicherung. Diese Profile können auf Treppen aller Art verwendet werden, unabhängig von dem verwendeten Treppenbelag. Das selbstklebende Profil kann auch als Parkettbodenabschluss verwendet werden und nimmt dessen Ausdehnung auf.

CULORI / COLOURS / FARBEN



AL **S46**

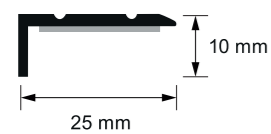

PROFIL PENTRU TREPTE
CU ŞURUB SAU AUTOADEZIV
STAIR NOSING PROFILE
WITH SCREW OR SELF-ADHESIVE

TREPPENKANTENPROFIL
SELBSTKLEBEND ODER ANSCHRAUBBAR

1 m, 3 m
10 buc/pcs/stück

RO Profilele pentru trepte au rolul de a proteja marginile treptelor de deteriorări. Profilul este prevăzut cu striații, având și rol antiderapant. Aceste profile pot fi folosite la toate treptele, indiferent de finisajul folosit pe suprafața lor.

EN Aluminium stair nosing profiles are designed to protect the edges of the stairs from damage. The profile is provided with ribs, thus also having an anti-skid feature. These profiles can be mounted on most surfaces.

DE Treppenprofile schützen die Treppenkanten vor Schäden. Das Profil ist gerieffelt und bildet somit eine Antirutsch-Sicherung. Diese Profile können auf Treppen aller Art verwendet werden, unabhängig von dem verwendeten Treppenbelag. Das selbstklebende Profil kann auch als Parkettbodenabschluss verwendet werden und nimmt dessen Ausdehnung auf.

CULORI / COLOURS / FARBEN



AL **S32**

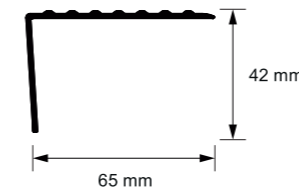

PROFIL PENTRU TREPTE
CU ŞURUB
STAIR NOSING PROFILE
WITH SCREW
TREPPENKANTENPROFIL
ANSCHRAUBBAR

0,9m, 2,7 m
5 buc/pcs/stück

RO Profilele pentru trepte au rolul de a proteja marginile treptelor de deteriorări. Profilul este prevăzut cu striații, având și rol antiderapant. Aceste profile pot fi folosite la toate treptele, indiferent de finisajul folosit pe suprafața lor.

EN Aluminium stair nosing profiles are designed to protect the edges of the stairs from damages. The profile is provided with ribs, thus also having an anti-skid feature. These profiles can be applied on most surfaces.

DE Treppenprofile schützen die Treppenkanten vor Schäden. Das Profil ist gerieffelt und bildet somit eine Antirutsch-Sicherung. Diese Profile können auf Treppen aller Art verwendet werden, unabhängig von dem verwendeten Treppenbelag.

CULORI / COLOURS / FARBEN



AL S33

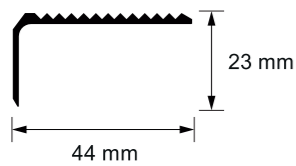

**PROFIL PENTRU TREPTE
CU ŞURUB**
**STAIR NOSING PROFILE
WITH SCREW**

**TREPPENKANTENPROFIL
ANSCHRAUBBAR**

0,93 m, 2,7 m
10 buc/pcs/stück

RO Profilele pentru trepte au rolul de a proteja marginile treptelor de deteriorări. Profilul este prevăzut cu striații, având și rol antiderapant. Aceste profile pot fi folosite la toate treptele, indiferent de finisajul folosit pe suprafața lor. Cel cu autoadeziv poate fi folosit și ca închidere pentru parchet, preluând dilatarea acestuia.

EN Aluminium stair nosing profiles are designed to protect the edges of the stairs from damage. The profile is provided with ribs, thus also having an anti-skid feature. These profiles can be mounted on most surfaces.

DE Treppenprofile schützen die Treppenkanten vor Schäden. Das Profil ist gerieffelt und bildet somit eine Antirutsch-Sicherung. Diese Profile können auf Treppen aller Art verwendet werden, unabhängig von dem verwendeten Treppenbelag. Das selbstklebende Profil kann auch als Parkettbodenabschluss verwendet werden und nimmt dessen Ausdehnung auf.

CULORI / COLOURS / FARBEN



AL S42

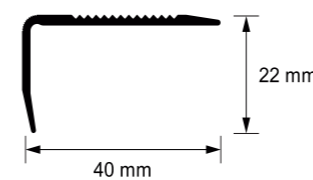

**PROFIL PENTRU TREPTE
CU ŞURUB SAU ADEZIV**
**STAIR NOSING PROFILE
WITH SCREW OR ADHESIVE**

**TREPPENKANTENPROFIL
KLEBSTOFF ODER ANSCHRAUBBAR**

0,9 m, 2,7 m
10 buc/pcs/stück

RO Profilele pentru trepte au rolul de a proteja marginile treptelor de deteriorări. Profilul este prevăzut cu striații, având și rol antiderapant. Aceste profile pot fi folosite la toate treptele, indiferent de finisajul folosit pe suprafața lor.

EN Aluminium stair nosing profiles are designed to protect the edges of the stairs from damages. The profile is provided with ribs, thus also having an anti-skid feature. These profiles can be applied on most surfaces.

DE Treppenprofile schützen die Treppenkanten vor Schäden. Das Profil ist gerieffelt und bildet somit eine Antirutsch-Sicherung. Diese Profile können auf Treppen aller Art verwendet werden, unabhängig von dem verwendeten Treppenbelag.

CULORI / COLOURS / FARBEN



AL S100

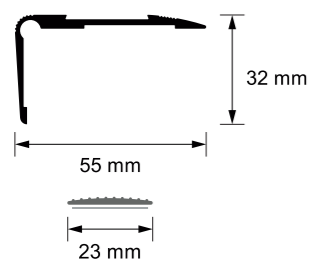

PROFIL PENTRU TREPTE
CU BANDĂ ANTIDERAPANTĂ
STAIR NOSING PROFILE
WITH NON-SLIP PVC INSERT
TREPPENKANTENPROFIL
MIT ANTI-RUTSCH BAND

1m, 3 m
5 buc/pcs/stück

RO Profilele pentru trepte cu bandă antiderapantă au un rol dublu: de a proteja marginile treptelor de deteriorări și de a preveni accidentele prin alunecare. Se pot utiliza atât în exterior cât și în interior. Au un aspect elegant, șuruburile fiind mascate de banda antiderapantă.

EN Aluminium stair nosing profiles with anti-skid PVC inserts have a dual role: to protect the edges of the stairs from damage and to prevent slips. They can be used both indoors and outdoors. They have a stylish look, the screws being masked by the anti-slip strip.

DE Die mit Anti-Rutschband versehene Treppenprofile haben eine doppelte Funktion: Sie schützen die Treppenkanten vor Beschädigungen und verhindern Rutschunfälle. Sie sind sowohl im Innen- als auch im Außenbereich einsetzbar. Sie sehen elegant aus, da die Schrauben durch den Anti-Rutschband verdeckt sind.

CULORI / COLOURS / FARBEN



PVC 20118 BANDĂ ANTIDERAPANTĂ 50 m
AUTOADEZIV SELF-ADHESIVE SELBSTKLEBEND NON-SLIP PVC BAND 1 buc/pcs/stück
ANTI-RUTSCH-KLEBEBAND

Banda antiderapantă are un rol de a preveni accidentele prin alunecare
Anti slip PVC band to help prevent slips.
Das Anti-Rutsch-Band trägt dazu bei, Rutschunfälle zu verhindern.

CULORI / COLOURS / FARBEN



AL S38

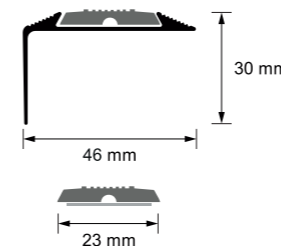

PROFIL PENTRU TREPTE
CU BANDĂ ANTIDERAPANTĂ
STAIR NOSING PROFILE
WITH NON-SLIP PVC INSERT
TREPPENKANTENPROFIL
MIT ANTI-RUTSCH BAND

0,93 m, 2,7 m
10 buc/pcs/stück

RO Profilele pentru trepte cu bandă antiderapantă au un rol dublu: de a proteja marginile treptelor de deteriorări și de a preveni accidentele prin alunecare. Se pot utiliza atât în exterior cât și în interior. Au un aspect elegant, șuruburile fiind mascate de banda antiderapantă.

EN Aluminium stair nosing profiles with anti-skid PVC inserts have a dual role: to protect the edges of the stairs from damage and to prevent slips. They can be used both indoors and outdoors. They have a stylish look, the screws being masked by the anti-slip strip.

DE Die mit Anti-Rutschband versehene Treppenprofile haben eine doppelte Funktion: Sie schützen die Treppenkanten vor Beschädigungen und verhindern Rutschunfälle. Sie sind sowohl im Innen- als auch im Außenbereich einsetzbar. Sie sehen elegant aus, da die Schrauben durch den Anti-Rutschband verdeckt sind.

CULORI / COLOURS / FARBEN



PVC 20105 BANDĂ ANTIDERAPANTĂ 200 m
NON-SLIP PVC BAND 1 buc/pcs/stück
ANTI-RUTSCH-KLEBEBAND

Banda antiderapantă are un rol de a preveni accidentele prin alunecare
Anti slip PVC band to help prevent slips.
Das Anti-Rutsch-Band trägt dazu bei, Rutschunfälle zu verhindern.

CULORI / COLOURS / FARBEN



AL **A60**

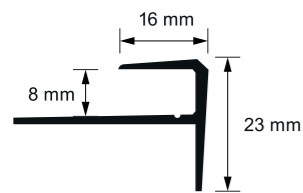

PROFIL PENTRU TREPTE
PENTRU PARCHET LAMINAT

STAIR NOSING
FOR LAMINATE FLOORING

TREPPENKANTENPROFIL
FÜR PARKETT

0,9m, 2,7 m
15 buc/pcs/stück

RO Profil de treaptă pentru parchet, protejează marginile treptelor de deteriorări, maschează și fixează marginile de parchet tăiate, crește rezistența la uzură a treptelor.

EN Aluminium stair nosing profiles are designed to protect the edges of the stairs from damages. The profile is provided with ribs, thus having an anti-skid feature. These profiles can be mounted on laminate flooring.

DE Treppenprofil für Parketboden - schützt die Treppenkanten vor Schäden, verdeckt und befestigt geschnittene Parkettkanten und erhöht die Verschleißfestigkeit der Treppen.

CULORI / COLOURS / FARBEN



AL **S06**

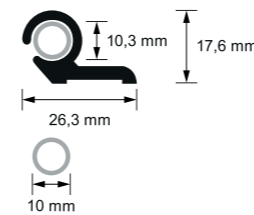

PROFIL PENTRU TREPTE
PENTRU FIXARE MOCHETĂ/COVOR

BAR FOR STAIRS
FOR STAIR CARPETING

TREPPENSTANGEN
FÜR TEPPICHE/ TREPPENLÄUFER

1 m
90 buc/pcs/stück

RO Profilul se utilizează pentru fixarea mochetei/covorului pe colțul interior al treptei, oferă un aspect elegant și contribuie la scăderea riscului de alunecare.

EN These profiles are used to affix the carpet to the inner corner of the stairs, while providing a stylish look and helping to reduce the risk of slippage.

DE Das Profil dient zur Befestigung von Teppichböden/Teppiche an den Innenkanten der Treppen, gewährleistet ein stilvolles Aussehen und verringert das Abrutschrisiko.

CULORI / COLOURS / FARBEN



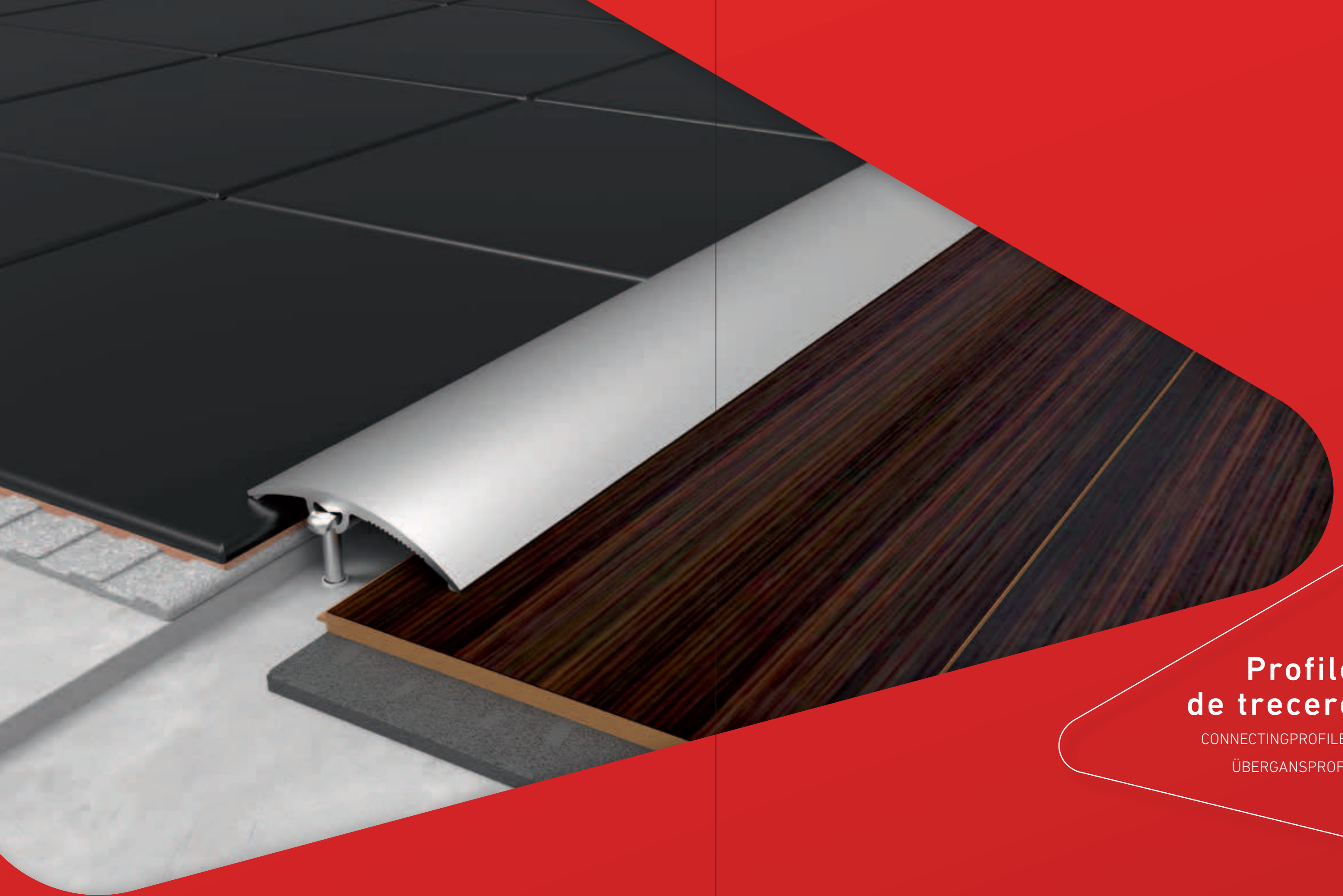

Profile de trecere

CONNECTINGPROFILES

ÜBERGANSPROFIL



AL S05

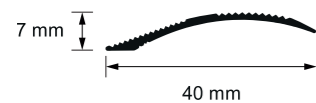

PROFIL DE TRECERE

CU DIFERENȚĂ DE NIVEL – CURBAT

CONNECTING PROFILE

FOR DIFFERENT-LEVEL FLOORS – ROUNDED

ÜBERGANGSPROFIL

FÜR UNTERSCHIEDLISCHE BODENHÖHEN – GEBOGEN

0,9 m, 2,7 m
10 buc/pcs/stück

RO Aceste profile se folosesc pentru a face trecerea între suprafețe cu diferență de nivel. Au rolul de a acoperi rostul dintre diferite materiale de finisare (mochetă/ parchet/gresie etc.) și de a compensa diferența de nivel, astfel contribuind și la scăderea riscului de accidentare. Se montează cu diblu și șurub.

EN Aluminium connecting profiles for different-level floors are used to connect floorings with a difference in level. They have the role to cover the connection between different finishing materials (carpet / parquet / tiles etc.) and to compensate for the level difference, thus also contributing to the reduction of the risk of accidents.

DE Diese Profile werden verwendet, um den Übergang zwischen Beläge mit unterschiedlichen Höhen zu gewährleisten. Sie haben die Aufgabe, die Fuge zwischen den verschiedenen Belagmaterialien (Teppich/Parkett/Fliesen usw.) abzudecken und den Höhenunterschied auszugleichen, was zur Verringerung der Verletzungsgefahr beiträgt.

CULORI / COLOURS / FARBEN



AL S01

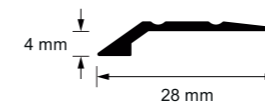

PROFIL DE TRECERE

CU DIFERENȚĂ DE NIVEL

CONNECTING PROFILE

FOR DIFFERENT-LEVEL FLOORS

ANPASSUNGSPROFIL

FÜR UNTERSCHIEDLISCHE BODENHÖHEN

0,93 m, 2,7 m
10 buc/pcs/stück

RO Aceste profile se folosesc pentru a face trecerea între suprafețe cu diferență de nivel. Au rolul de a acoperi rostul dintre diferite materiale de finisare (mochetă/ parchet/gresie etc.) și de a compensa diferența de nivel, astfel contribuind și la scăderea riscului de accidentare. Se montează cu diblu și șurub.

EN Aluminium connecting profiles for different-level floors are used to connect floorings with a difference in level. They have the role to cover the connection between different finishing materials (carpet / parquet / tiles etc.) and to compensate for the level difference, thus also contributing to the reduction of the risk of accidents.

DE Diese Profile werden verwendet, um den Übergang zwischen Beläge mit unterschiedlichen Höhen zu gewährleisten. Sie haben die Aufgabe, die Fuge zwischen den verschiedenen Belagmaterialien (Teppich/Parkett/Fliesen usw.) abzudecken und den Höhenunterschied auszugleichen, was zur Verringerung der Verletzungsgefahr beiträgt.

CULORI / COLOURS / FARBEN



AL **S39**

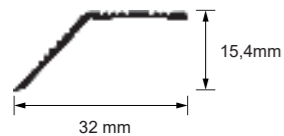

PROFIL DE TRECERE
CU DIFERENȚĂ DE NIVEL

CONNECTING PROFILE
FOR DIFFERENT-LEVEL FLOORS

ANPASSUNGSPROFIL
FÜR UNTERSCHIEDLISCHE BODENHÖHEN

0,9 m, 2,7 m
10 buc/pcs/stück

RO Aceste profile se folosesc pentru a face trecerea între suprafețe cu diferență de nivel. Au rolul de a acoperi rostul dintre diferite materiale de finisare (mochetă/ parchet/gresie etc.) și de a compensa diferența de nivel, astfel contribuind și la scăderea riscului de accidentare. Se montează cu diblu și șurub.

EN Aluminium connecting profiles for different-level floors are used to connect floorings with a difference in level. They have the role to cover the connection between different finishing materials (carpet / parquet / tiles etc.) and to compensate for the level difference, thus also contributing to the reduction of the risk of accidents.

DE Diese Profile werden verwendet, um den Übergang zwischen Beläge mit unterschiedlichen Höhen zu gewährleisten. Sie haben die Aufgabe, die Fuge zwischen den verschiedenen Belagmaterialien (Teppich/Parkett/Fliesen usw.) abzudecken und den Höhenunterschied auszugleichen, was zur Verringerung der Verletzungsgefahr beiträgt.

CULORI / COLOURS / FARBEN



AL **S02**



PROFIL DE TRECERE
AUTOADEZIV SAU CU ȘURUB ȘI DIBLU

CONNECTING PROFILE
WITH SCREW OR SELF-ADHESIVE

ÜBERGANGSPROFIL
SELBSTKLEBEND ODER ANSCHRAUBBAR

0,93 m, 2,7 m
10 buc/pcs/stück

RO Profilele de trecere se folosesc pentru a face trecerea între pardoseli fără diferență de nivel, de ex. între parchet și gresie sau între parchet și parchet. Asigură un aspect estetic și acoperă rosturile. Se montează cu diblu și șurub, sau autoadeziv.

EN The aluminium connecting profiles for same-level floors are used to connect floors without any level difference, for example between parquet and tiles or between parquet and parquet. They ensure an aesthetic appearance and cover gaps. They are mounted with screw and dowel or self-adhesive tape, depending on the model chosen.

DE Übergangprofile werden eingesetzt, um den Übergang zwischen Beläge mit gleicher Höhe, z. B. zwischen Parkettbelag und Fliesenbelag oder zwischen Parkett und Parkett, zu gewährleisten. Gewährleistet ein ästhetisches Aussehen und verdeckt die Fugen. Lassen sich mit Schrauben und Dübel montieren.

CULORI / COLOURS / FARBEN



AL S03

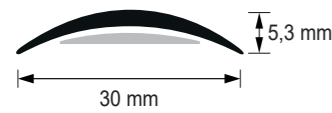

PROFIL DE TRECERE

CURBAT

CONNECTING PROFILE

ROUNDED

ÜBERGANGSPROFIL

GEBOGENES

0,93 m, 2,7 m
10 buc/pcs/stück

RO Profilele de trecere se folosesc pentru a face trecerea între pardoseli fără diferență de nivel, de ex. între parchet și gresie sau între parchet și parchet. Asigură un aspect estetic și acoperă rosturile.

EN The aluminium connecting profiles for same-level floors are used to connect floors without any level difference, for example between parquet and tiles or between parquet and parquet. They ensure an aesthetic appearance and cover gaps. They are mounted with screw and dowel or self-adhesive tape, depending on the model chosen.

DE Übergangprofile werden eingesetzt, um den Übergang zwischen Beläge mit gleicher Höhe, z. B. zwischen Parkettbelag und Fliesenbelag oder zwischen Parkett und Parkett, zu gewährleisten. Gewährleistet ein ästhetisches Aussehen und verdeckt die Fugen. Lassen sich mit Schrauben und Dübel montieren.

CULORI / COLOURS / FARBEN



AL S04

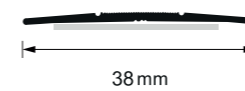

PROFIL DE TRECERE

AUTOADEZIV

CONNECTING PROFILE

SELF-ADHESIVE

ÜBERGANGSPROFIL

SELBSTKLEBEND

0,9 m, 2,7 m
10 buc/pcs/stück

RO Profilele de trecere se folosesc pentru a face trecerea între pardoseli fără diferență de nivel, de ex. între parchet și gresie sau între parchet și parchet. Asigură un aspect estetic și acoperă rosturile. Se montează cu diblu și șurub, sau autoadeziv.

EN The aluminium connecting profiles for same-level floors are used to connect floors without any level difference, for example between parquet and tiles or between parquet and parquet. They ensure an aesthetic appearance and cover gaps. They are mounted with screw and dowel or self-adhesive tape, depending on the model chosen.

DE Übergangprofile werden eingesetzt, um den Übergang zwischen Beläge mit gleicher Höhe, z. B. zwischen Parkettbelag und Fliesenbelag oder zwischen Parkett und Parkett, zu gewährleisten. Gewährleistet ein ästhetisches Aussehen und verdeckt die Fugen. Lassen sich mit Schrauben und Dübel montieren.

CULORI / COLOURS / FARBEN



AL S63

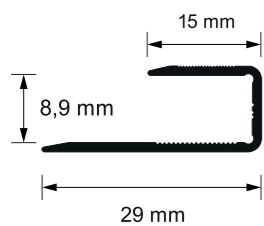

PROFIL DE TERMINAȚIE
PENTRU PARCHET LAMINAT
CLOSING PROFILE
FOR LAMINATED FLOORINGS
ABSCHLUSSPROFIL
FÜR LAMINATBÖDEN

0,9 m, 2,7 m
20 buc/pcs/stück

- RO** Terminație de parchet, se utilizează în locuri unde nu se poate monta plintă pentru parchet (prag, ușă de balcon). Asigura un finisaj estetic pentru muchiile de parchet tăiate.
- EN** Aluminium closing profiles are used in places where parquet skirting cannot be mounted (thresholds, balcony doors). These ensure an aesthetic finish for cut parquet edges.
- DE** Abschlussprofile für Parkettböden werden dort verwendet, wo kein Parkettboden-Sockelleiste montiert werden kann (Schwelle, Balkontür). Sorgt für ein ästhetisches Abschluss der geschnittenen Fliesenkanten.

CULORI / COLOURS / FARBEN



AL S64



PROFIL DE TRECERE CU ȘURUB MASCAT
CU DIFERENȚĂ DE NIVEL VARIABILĂ
CONNECTING PROFILE WITH HIDDEN SCREW
WITH VARIABLE DIFFERENT LEVEL
ÜBERGANGSPROFIL MIT VERSETCKEN
SCHRAUBEN
MIT VARIABLEN NIVEAUDIFFERENZ

0,93 m, 2,7 m
10 buc/pcs/stück

- RO** Profilele de trecere se folosesc pentru a face trecerea între pardoseli cu sau fără diferență de nivel, de ex. între parchet și gresie sau între parchet și parchet. Acoperă rosturile și asigură un aspect estetic. Profilele sunt disponibile în mai multe culori inclusiv pe imitație de lemn, și astfel pot fi asortate cu parchetul. Sistemul de prindere cu șurub mascat conferă un plus de eleganță.
- EN** Aluminium connecting profiles with hidden screws are used to connect floors, for example between parquet and tiles or between parquet and parquet. They cover the gaps and provide an aesthetic appearance. The masked screw fastening system adds elegance, the product is available in a wide range of colors and in wood imitations to ensure a perfect match with the flooring.
- DE** Übergangprofile werden eingesetzt, um den Übergang zwischen Beläge mit gleicher Höhe bzw. kleine Höhenunterschiede, z. B. zwischen Parkettbelag und Fliesenbelag oder zwischen Parkett und Parkett, zu gewährleisten. Bedecken die Fugen und sorgen für ein ästhetisches Aussehen. Die Profile sind in verschiedenen Farben erhältlich, einschließlich Holzimitat, und können mit dem Parkett zusammenpasst werden. Das Befestigungssystem mit versteckten Schrauben verleiht der Oberfläche mehr Eleganz.

CULORI / COLOURS / FARBEN



AL S65



PROFIL DE TRECERE CU ȘURUB MASCAT
CU DIFERENȚĂ DE NIVEL VARIABILĂ

0,93 m, 2,7 m
10 buc/pcs/stück

CONNECTING PROFILE WITH HIDDEN SCREW
FOR DIFFERENT-LEVEL FLOORS

ANPASSUNGSPROFIL MIT VERSTECKTEN SCHRAUBEN
FÜR UNTERSCHIEDLICHE BODENHÖHEN

RO Profil de trecere cu diferență de nivel și șurub mascat. Profilul face trecerea între pardoseli cu diferență de nivel (gresie, faianță, parchet etc.), asigură un aspect estetic și acoperă rosturile de dilatație, la suprafețe mari acoperite cu parchet se recomandă întreruperea parchetului, rostul fiind mascat cu profilul de trecere.

EN Aluminium connecting profiles with hidden screws are used to connect floors with different heights. They are designed to cover the connection between the different finishing materials (carpet / parquet / tiles etc.) and to compensate for the level difference, thus also contributing to the reduction of the risk of accidents.

DE Anpassungsprofil mit versteckten Schrauben für Beläge mit unterschiedlicher Höhe. Das Profil bildet den Übergang zwischen Belägen mit unterschiedlichen Höhen (Fliesen, Parkett usw.), sorgt für ein ästhetisches Aussehen und verdeckt die Dehnungsfugen. Bei großen Parkettflächen wird empfohlen, den Parkett zu unterbrechen, wobei die Fuge mit dem Anpassungsprofil abgedeckt wird.

CULORI / COLOURS / FARBEN



AL S66



PROFIL DE TRECERE CU ȘURUB MASCAT
CU DIFERENȚĂ DE NIVEL VARIABILĂ

0,93 m, 2,7 m
10 buc/pcs/stück

CONNECTING PROFILE WITH HIDDEN SCREW
WITH VARIABLE DIFFERENT LEVEL

ÜBERGANGSPROFIL MIT VERSETCKEN SCHRAUBEN
FÜR UNTERSCHIEDLICHE BODENHÖHEN

RO Profilele de trecere se folosesc pentru a face trecerea între pardoseli cu sau fără diferență de nivel, de ex. între parchet și gresie sau între parchet și parchet. Acoperă rosturile și asigură un aspect estetic. Profilele sunt disponibile în mai multe culori inclusiv pe imitație de lemn, și astfel pot fi asortate cu parchetul. Sistemul de prindere cu șurub mascat conferă un plus de eleganță.

EN Aluminium connecting profiles with hidden screws are used to connect floors, for example between parquet and tiles or between parquet and parquet. They cover the gaps and provide an aesthetic appearance. The masked screw fastening system adds elegance, the product is available in a wide range of colors and in wood-imitations to ensure a perfect match with the flooring.

DE Übergangprofile werden eingesetzt, um den Übergang zwischen Beläge mit gleicher Höhe bzw. kleine Höhenunterschiede, z. B. zwischen Parkettbelag und Fliesenbelag oder zwischen Parkett und Parkett, zu gewährleisten. Bedecken die Fugen und sorgen für ein ästhetisches Aussehen. Die Profile sind in verschiedenen Farben erhältlich, einschließlich Holzimitat, und können mit dem Parkett zusammenpasst werden. Das Befestigungssystem mit versteckten Schrauben verleiht der Oberfläche mehr Eleganz

CULORI / COLOURS / FARBEN



AL **A69**

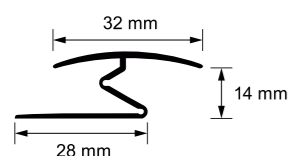

PROFIL DE TRECERE
CU DIFERENȚĂ DE NIVEL VARIABILĂ
CONNECTING PROFILE
WITH VARIABLE DIFFERENT-LEVEL

ANPASSUNGSPROFILE FÜR BELÄGE
MIT VARIABLEN NIVEAUDIFFERENZ

0,9 m, 2,7 m
15 buc/pcs/stück

RO Face trecerea între diferite tipuri de pardoseli • ajustabil în funcție de mărimea diferenței de nivel • acoperă rostul dintre diferite materiale de finisare (mochetă/parchet/gresie etc.) • compensează diferența de nivel • contribuie la scăderea riscului de accidentare • se montează cu diblu și holșurub înainte de montarea parchetului. După montarea parchetului se presează cu un lemn de esenta moale (ex. brad).

EN Aluminium connecting profiles for different-level floors are used to connect floorings with a difference in level. They are meant to cover the connection between different finishing materials (carpet / parquet / tiles etc.) and to compensate for the level difference, thus also contributing to the reduction of the risk of accidents.

DE Gewährleistet den Übergang zwischen unterschiedlichen Bodenbelagsarten • je nach Größe des Höhenunterschieds verstellbar • deckt die Fuge zwischen unterschiedlichen Belagmaterialien (Teppichboden/Parkett/Fliesen usw.) ab • gleicht den Höhenunterschied aus • trägt zur Verringerung des Verletzungsrisikos bei - Lässt sich mit Dübeln und Hohlschrauben vor dem Verlegen des Parketts montieren. Nach dem Verlegen des Parketts drücken Sie es mit Weichholz (z.B. Tanne).

CULORI / COLOURS / FARBEN



PVC **51101**

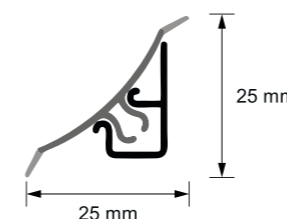

PROFIL ÎNĂLȚĂTOR
PENTRU BLAT BUCĂTĂRIE
EDGE PROFILE
FOR KITCHEN COUNTERTOPS
ERHÖHUNGSPROFIL
FÜR KÜCHENARBEITSPLATTEN

3 m
10 buc/pcs/stück

ACCESORII / ACCESSORIES / ZUBEHÖR

RO Profilul înălțător pentru blat bucătărie este recomandat pentru finisarea estetică a rostului între perete și mobilă, asigurând un racord estetic între blat și perete. Se montează ușor iar marginile flexibile asigură etanșarea suprafețelor. Cu ajutorul accesoriilor se poate realiza o îmbinare perfectă între plinte.

EN Kitchen countertop edge profiles are recommended for finishing the grout line between the wall and the furniture, ensuring an aesthetic connection between the wall and the countertop. They are easy to apply and their flexible edges seal the surfaces. With the help of the accessories profiles can be joined flawlessly.

DE Das Aufzugsprofil für Küchenarbeitsplatten wird empfohlen, um die Verbindung zwischen Wand und Möbel ästhetisch zu gestalten und ein ästhetischer Übergang zwischen Arbeitsplatte und Wand zu erhalten. Lässt sich leicht verlegen und die flexible Kanten sorgen für die Abdichtung der Oberflächen. Mit dem Zubehör kann ein perfekter Übergang zwischen den Profilen erzielt werden.

CULORI / COLOURS / FARBEN





PLINTE & PROFILE



- RO SISTEM ANTIDESPINDERE
- EN ANTI DETACHMENT SYSTEM
- DE FEST MONTIERBAR



- RO SE MONTEAZĂ CU ȘURUB
- EN SHOULD BE ATTACHED WITH SCREW
- DE ANSCHRAUBBAR



- RO CU ȘURUB MASCAT
- EN WITH HIDDEN SCREW
- DE MIT VERSTECKTEN SCHRAUBEN



- RO AUTOADEZIV
- EN SELF-ADHESIVE
- DE SELBSTKLEBEND



- RO SE MONTEAZĂ CU ADEZIV
- EN SHOULD BE ATTACHED WITH GLUE
- DE WIRD GEKLEBT



- RO SE MONTEAZĂ ÎN ADEZIV (PENTRU FAIANȚĂ)
- EN SHOULD BE ATTACHED IN GLUE (FOR CERAMIC TILES)
- DE WIRD IN KLEBER (FÜR WANDFLIESEN) VERSTECKT



PLINTE & PROFILE

SET PROD-COM S.R.L

Str. Leliceni 49 / 8
RO-530190 Miercurea Ciuc
+40 266 372 425

www.plinte-profile.ro